



PERFORMANCE PRODUCTS

2017 CATALOG



2016 Camaro SS Equipped with Hurst Elite Series Package

TABLE OF CONTENTS

04

Hurst Elite Series

- 04 Build Your Own Hurst Car
- 05 Floor Mats
- 06 Exhaust Systems
- 08 Suspension
- 10 Wheels
- 14 Graphics Packs

16 Line/Loc

18

Manual Shifters

- 18 Billet/Plus Shifters
- 30 Competition/Plus Shifters
- 38 Street Super Shifter
- 39 Mastershift
- 40 Indy Shifter
- 42 Nitro Shifter Sticks
- 44 Flat & Round Bar Shifter Sticks
- 47 Pistol-Grip Shifter Sticks
- 48 Classic Shifter Knobs
- 49 Shifter Boots
- 50 Universal Pistol-Grip
- 51 Universal T-Handle

52

Automatic Shifters

- 52 Pro-Matic 2
- 53 V-Matic 3
- 54 Quarter Stick
- 55 Pistol-Grip Quarter Stick
- 56 Quarter Stick Accessories
- 58 Pistol-Grip Automatic Shifter Sticks
- 59 Comp Stick Kit

60

- 60 Accessories
- 61 Service Parts & Warranty
- 62 Transmission ID Chart
- 64 Hurst Gear & Apparel

ELITE SERIES PACKAGES

Build Your Own Modern Day Hurst Car

Have you always wanted to buy a Hurst-built performance car, but just couldn't afford the high price tag? Now you can build your own version of a modern day Hurst car at the pace you desire and at a cost you can afford. Our engineers have been hard at work designing the highest quality performance products that you can buy for your modern muscle car, all while living up to the legendary Hurst name.

How It Works

In order for your car to qualify for the program, it must be fitted with the following Hurst "Elite Series" items: exhaust, wheels, springs, floor mats, graphics and a Hurst shifter. Once you've purchased all six items, contact Hurst directly with the proof of purchase information and we'll add you and your car to our exclusive Hurst "Elite Series" build database. We'll also send you a limited edition metal Hurst "Elite Series" badge for your car and an officially numbered "Hurst Elite Series" build certificate, allowing you to show off your pride of building your very own Hurst "Elite Series" car!

Hurst "Elite Series" packages are available for modern Challengers, Chargers, Camaros and Mustangs.

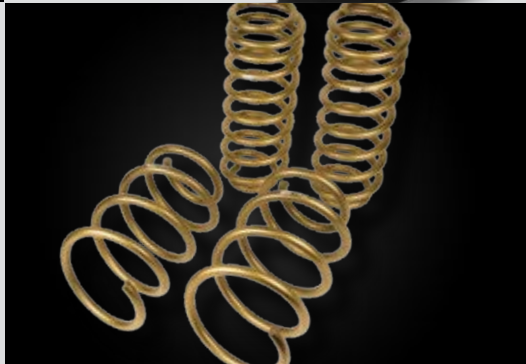
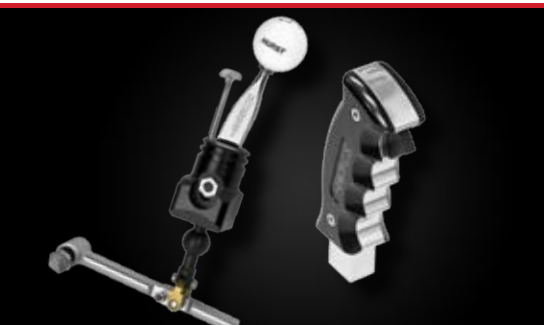



FLOOR MATS

About Hurst Vehicle Specific Floor Mats

Floor Mat Kit includes a 4-piece set of durable, front and rear black carpet mats including an embroidered Hurst logo with your choice of either red or gold Hurst "H" accent. These mats are cut to an OEM fit with OEM-style attachment and non-slide mat backing. Rear mats not shown.

CHEVROLET	YEAR	PART# (RED)	PART# (GOLD)
Camaro (Front Mats Only)	2016-2017	6370003	6371003
Camaro	2010-2015	6370000	6371000
DODGE			
Challenger	2008-2016	6370010	6371010
Charger	2015-2016	6370011	6371011
FORD			
Mustang	2015-2017	6370021	6371021
Mustang	2010-2014	6370020	6371020



EXHAUST

Stainless Steel Systems for Modern Muscle

Hurst Elite Series exhaust systems are constructed using the highest quality materials and finest craftsmanship available today, bar none! Hurst Elite Series systems feature fully mandrel-bent 304s stainless steel tubing that has been custom designed and exclusively manufactured by industry-leading Flowmaster Inc. to ensure a precise fit every time! The Hurst engineers then added an X-pipe crossover which provides maximum scavenging, sound, and performance, and paired it with a set of fully polished 304s stainless steel Hurst mufflers. The mufflers utilize a high-thermal sound absorption barrier with a large 3" straight-through performance core that provides a deep, classic tone reminiscent of Hurst's iconic heritage.

The mirror-polished stainless steel tips, featuring laser-etched Hurst logos finish off the system and put the world on notice that you're serious about performance and style. You can take comfort and pride in knowing that every Hurst Elite Series exhaust system is hand-fabricated in the USA and backed by a Lifetime Limited Warranty.





CHEVROLET	YEAR	SYSTEM TYPE	PART#
Camaro SS	2016-2017	Axle-Back (Not for GM Performance Exhaust Option)	6350026
Camaro SS	2014-2015	Cat-Back (Not for Dual Mode / Quad Tip Option)	6350001
Camaro SS	2010-2013	Cat-Back (Not for Models with Ground Effects Option)	6350002
DODGE			
Challenger SRT392 / Hellcat / Scat Pack 6.2 & 6.4	2015-2016	Cat-Back	6350014
Challenger R/T	2015-2016	Cat-Back	6350013
Challenger R/T	2009-2014	Cat-Back	6350011
Challenger SRT8 6.1 & 6.2	2008-2014	Cat-Back	6350010
Charger R/T	2015-2016	Cat-Back	6350017
Charger R/T	2011-2014	Cat-Back	6350016
FORD			
Mustang GT	2015-2017	Cat-Back	6350024
Mustang 2.3L EcoBoost I4 / 3.7L V6	2015-2017	Axle-Back	6350027
Mustang GT	2013-2014	Cat-Back	6350023
Mustang GT	2011-2012	Cat-Back	6350022



SPRINGS

High Performance Lowering Springs

The Hurst High-Performance Spring Kit is an excellent choice for firming up the handling of your car and giving it that “Just Right” stance. These springs will lower your vehicle approximately one inch, closing up the fender gap, lowering your center of gravity for improved handling and braking, and improving overall driving feel. Through careful design and rate tailoring, the Hurst High-Performance Spring Kit accomplishes all of the above while still being street-friendly.

CHEVROLET	YEAR	PART#
Camaro SS	2016-2017	6130001
Camaro SS	2010-2014	6130000
DODGE		
Challenger R/T & SRT	2011-2016	6130010
Charger R/T	2011-2016	6130012
FORD		
Mustang GT	2015-2017	6130022
Mustang (All Models)	2011-2014	6130020

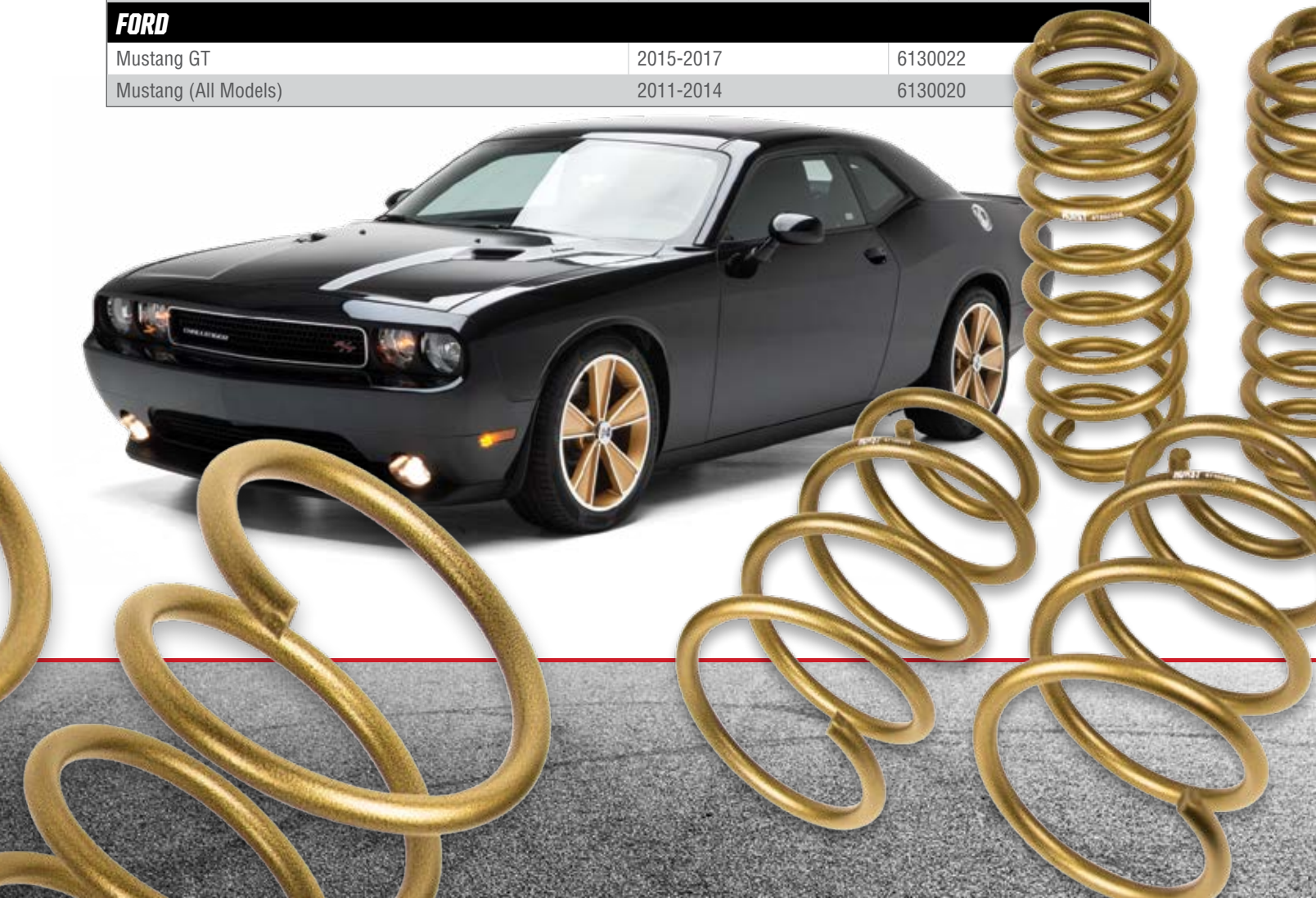

SUSPENSION

High Performance Suspension Kits

The Hurst High-Performance Suspension Kit will lower your vehicle approximately one inch, and also increase roll stiffness. These two small changes close up that fender gap, lower your center of gravity for improved handling and braking, and keep body roll to a minimum. From the very first drive, you will notice a more neutral balance to the vehicle, precision turn-in capability, and increased cornering grip.

CHEVROLET	YEAR	PART#
Camaro SS	2013-2014	6320001
Camaro ZL1	2010-2014	6320001
Camaro SS	2010-2012	6320000
DODGE		
Challenger R/T & SRT	2011-2014	6320010
FORD		
Mustang (All Models)	2011-2014	6320020





THE SHAKER

- » **20" WHEEL DIAMETER**
- » **BLACK AND GOLD INSERTS INCLUDED WITH WHEEL**
- » **INSERTS CAN BE EASILY PAINTED TO MATCH BODY COLOR**



Red Logo Center Cap for Shaker (6360000)

Gold Logo Center Cap for Shaker (6361000)





THE DAZZLER

- » 15," 17," 20" WHEEL DIAMETERS
- » PROTECTIVE CLEAR COAT
- » BLACK OR GOLD WITH MACHINED FACE



Red Logo Center Cap for Dazzler (6360000)

Gold Logo Center Cap for Dazzler (6361000)





THE STUNNER

- >> **20" WHEEL DIAMETER**
- >> **BLACK WITH MACHINED FACE (CAR + TRUCK FITMENTS)**
- >> **CHROME FINISH (EXCLUSIVE FOR TRUCK FITMENTS)**



Red Center Cap for Stunner (6360001) (114mm Bolt Pattern)

Red Center Cap for Stunner (6360002) (All Other 5 Lug)

Red Center Cap for Stunner (6360003) (All 6 Lug)



Wheel Applications

WHEEL STYLE	FINISH	SIZE	BOLT PATTERN	OFFSET (MM)	BACK SPACING (IN)	BORE DIAM. (MM)	WEIGHT (LBS)	MAX LOAD (LBS)	PART #
Dazzler	Gold	15x6	5-4.75	ET0	3.50"	83	15.9	1800	806046
Dazzler	Gold	15x7	5-4.75	ET-5	3.75"	83	16.7	1800	806044
Dazzler	Gold	15x8	5-4.75	ET-5	4.00"	83	17.9	1800	806043
Dazzler	Gold	17x8	5-4.75	ET0	4.50"	83	23.2	1800	806039
Dazzler	Gold	17x9	5-4.75	ET+45	6.75"	70.7	22.9	1800	806045
Dazzler	Gold	17x10.5	5-4.75	ET+44	7.50"	70.7	24.2	1800	806047
Dazzler	Gold	20x8.5	5-115	ET+18	5.50"	71.5	33.3	1540	806026
Dazzler	Gold	20x8.5	5-120	ET+32	6.00"	66.9	32.2	1540	806036
Dazzler	Gold	20x10	5-115	ET+18	6.25"	71.5	34.9	1540	806028
Dazzler	Gold	20x10	5-120	ET+34	6.85"	66.9	33.6	1540	806050
Dazzler	Black	15x6	5-114	ET0	3.50"	83	16	1800	800208
Dazzler	Black	15x6	5-4.75	ET0	3.50"	83	16	1800	806042
Dazzler	Black	15x7	5-114	ET0	4.00"	83	16.6	1800	800207
Dazzler	Black	15x7	5-4.75	ET-5	3.75"	83	16.7	1800	806037
Dazzler	Black	15x8	5-4.75	ET-12	4.00"	83	17.8	1800	806040
Dazzler	Black	17x8	5-114	ET0	4.50"	83	23	1800	800209
Dazzler	Black	17x8	5-114	ET+30	5.75"	70.6	21.8	1800	800211
Dazzler	Black	17x8	5-4.75	ET0	4.50"	83	23.1	1800	806041
Dazzler	Black	17x9	5-114	ET+24	6.00"	70.6	23.6	1800	800210
Dazzler	Black	17x9	5-114	ET+45	6.75"	70.6	22.6	1800	800206
Dazzler	Black	17x9	5-4.75	ET+45	6.75"	70.7	22.9	1800	806038
Dazzler	Black	17x10.5	5-114	ET+28	7.00"	70.6	25	1800	800212
Dazzler	Black	17x10.5	5-4.75	ET+44	7.50"	70.7	23.6	1800	806048
Dazzler	Black	20x8.5	5-114	ET+32	6.00"	83	31.5	1540	800204
Dazzler	Black	20x8.5	5-115	ET+18	5.50"	71.5	32.6	1540	806024
Dazzler	Black	20x8.5	5-120	ET+32	6.00"	67	31.8	1540	806035
Dazzler	Black	20x10	5-114	ET+35	6.90"	83	34.3	1540	800213
Dazzler	Black	20x10	5-115	ET+18	6.25"	71.5	34.9	1540	806027
Dazzler	Black	20x10	5-120	ET+34	6.85"	66.9	34.8	1540	806049
Shaker	Black/Gold	20x8.5	5-114	ET+32	6.00"	83	30.2	1540	800205
Shaker	Black/Gold	20x8.5	5-115	ET+18	5.50"	71.5	34.9	1540	806023
Shaker	Black/Gold	20x8.5	5-120	ET+32	6.00"	66.9	30.2	1540	806034
Shaker	Black/Gold	20x10	5-114	ET+35	6.90"	83	33.4	1540	800214
Shaker	Black/Gold	20x10	5-115	ET+18	6.25"	71.5	31.2	1540	806025
Shaker	Black/Gold	20x10	5-120	ET+34	6.85"	66.9	33.6	1540	806032
Stunner	Black	20x9	5-114	ET+32	6.25"	70.6	35.5	1900	800302
Stunner	Black	20x9	5-115	ET+13	5.50"	71.5	35.6	1900	806321
Stunner	Black	20x9	5-120	ET+32	6.25"	67.1	35.1	1900	806331
Stunner	Black	20x9	6-135	ET+30	6.15"	87.1	33.8	2400	806303
Stunner	Black	20x9	6-139	ET+30	6.15"	78.1	33.8	2400	806304
Stunner	Black	20x9	5-139	ET+8	5.29"	77.8	35.5	2400	806305
Stunner	Black	20x9	6-5.31	ET+20	6.15"	87.1	35.6	2400	806306
Stunner	Black	20x9	6-5.50	ET+20	6.15"	78.1	35.6	2400	806307
Stunner	Black	20x10	5-114	ET+40	7.00"	70.6	35.5	1900	800303
Stunner	Black	20x10	5-115	ET+23	6.30"	71.5	37	1900	806322
Stunner	Black	20x11	5-120	ET+40	7.60"	67.1	39	1900	806333
Stunner	Black	22x9.5	6-135	ET+30	6.41"	87.1	38.4	2400	806300
Stunner	Black	22x9.5	6-139	ET+30	6.41"	78.1	39	2400	806301
Stunner	Black	22x9.5	5-139	ET+8	5.54"	77.8	41.2	2400	806302
Stunner	Chrome	20x9	6-135	ET+30	6.15"	87.1	34.5	2400	806403
Stunner	Chrome	20x9	6-139	ET+30	6.15"	78.1	34.25	2400	806404
Stunner	Chrome	20x9	5-139	ET+8	5.29"	77.8	35.5	2400	806405
Stunner	Chrome	22x9.5	6-135	ET+30	6.41"	87.1	39.7	2400	806400
Stunner	Chrome	22x9.5	6-139	ET+30	6.41"	78.1	39.7	2400	806401
Stunner	Chrome	22x9.5	5-139	ET+8	5.54"	77.8	41.2	2400	806402



GRAPHICS PACKS

Show Your Hurst Pride

Let everyone know that you're part of an elite group of automotive enthusiasts by equipping your car with a set of these Hurst graphics. Printed, laminated and trimmed by licensed specialists, these decals are made from the highest quality automotive grade vinyl for extended warranty against fade and easy application. Graphics packs are sold as 10 piece sets available in either Red/Black or Gold/Black.

RED GRAPHICS PACK (1320000)



GOLD GRAPHICS PACK (1321000)





HURST

HEMI

P ZERO



LINE/LOC®

Complete Roll Control System

Designed with simplicity and ease-of-install in mind, Hurst's complete Line/Loc kits use the absolute best-quality, pre-bent, double-walled stainless steel brake lines. In many cases, these hard-lines are superior to OEM quality. Hurst engineers realized when developing these kits that less really is more. Fewer connection points means fewer places where the system can leak and shorter lines mean less time bleeding the system. These kits are direct bolt-in meaning no measuring, no cutting, and no pre-bending; just simple, clean, factory-looking installs right out of the box.

This is used primarily in drag racing to provide positive locking action to the front wheels of racecars, reducing the chance of "Rolling the Lights" and producing more effective burnouts for heating up the tires. Rigorous testing has proved a 1/100,000 of a second release time and vibration tests have seen up to 30 Gs applied without mechanical failure. Adaptable to most domestic and import hydraulic brake systems. CAUTION: Hurst Line/Loc Should not be used as an emergency brake, or any application requiring the solenoid to be activated for a long period of time.

COMPLETE LINE/LOC KITS	YEAR	PART#
Chevrolet Camaro	11-15	5671518
Dodge Challenger	11-14	5671520
Dodge Challenger	08-10	5671517
Ford Mustang	11-14	5671519
Ford Mustang GT	05-09	5671521
Universal Kit	----	1745000
LINE/LOC SOLENOID		
Line/Loc Solenoid	----	5667550
Line/Loc Rebuild Kit	----	5671500
LINE/LOC ADAPTER FITTINGS KIT		
Chevrolet Camaro/Pontiac Firebird	93-02	5671515
Chevrolet Corvette	85-96	5671515
Ford Mustang (w/o Bosch ABS)	83-11	5671516

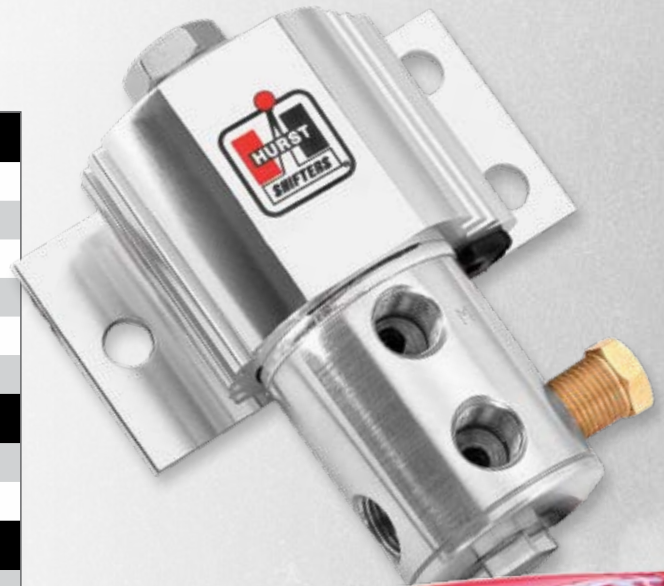

FEATURES & BENEFITS

- » Advanced Stainless Steel Valve Assembly for Ultimate Corrosion Resistance
- » Fully-Enclosed Epoxy-Molded Electrical Coil for Reliability
- » Attractive, Finned-Aluminum Housing Helps Dissipate Heat
- » Wider, Lightweight Base Provides Better Mounting Stability
- » 150-Micron Screen Filtered Ports to Prevent Contamination
- » Extra Threaded Port for Separate Bleeder or Brake Line Pressure Gauge



LINE/LOC[®]

Accessories



LINE/LOC INSTALLATION KIT
Part #5671510



SNAP-ACTION SPIRAL CORD SWITCH
Part #483880



LINE/LOC ADAPTER FITTINGS KIT
Part #5671515



COMPETITION KNOB W/ SWITCH
7/16"-20 • Part #1630050



REPLACEMENT SWITCH
Part #2483875



MODERN SWITCH KIT
Part #2483876



BILLET/PLUS[®] SHIFTERS

The Highest Quality Manual Shifters Available

Carved out of solid pieces of strong, high-quality steel and aluminum, Hurst Billet/Plus shifters are designed by engineers with the best equipment and technology available. This is all backed by the history, heritage, and knowledge that Hurst has acquired over half of a century of shifter design. Which other shifter manufacturer works directly with OE vehicle manufacturers to provide the best shifter available? Only Hurst!

CHEVROLET	YEAR	ENGINE	PART#	NOTES
Camaro SS	16-17	V8	3916031	Chrome Stick w/ White Knob
Camaro SS	16-17	V8	3916131	Black Pistol Grip
Camaro LT	16-17	I4/V6	3916034	Black Pistol Grip
Camaro	10-15	V6/V8	3916030	
Camaro	93-02	V8	3915060	Fits Stock Knob Only
Camaro	93-02	V8	3915061	Chrome Stick & Black Knob Only
Corvette C6/C7	05-15	V8	3915086	May Not Fit Stock Knob On Some Models
Corvette C5	97-04	V8	3915085	
DODGE				
Challenger	09-16	V8	3916020	Chrome Stick w/ White Knob
Challenger	09-16	V8	3916120	Black Pistol Grip
FORD				
Mustang	11-14	V6/V8	3910204	
Mustang	05-10	V8	3915201	
Mustang	01-04	V8	3915035	Fits Stock Knob Only, Fits T-5/T-45 Trans
Mustang	83-04	V6	3915033	Chrome Stick & White Knob Only
Mustang	83-04	V6	3915031	Fits Stock Knob Only
Mustang	83-01	V8	3915033	Chrome Stick & White Knob Only
Mustang	83-01	V8	3915031	Fits Stock Knob Only
Ranger	88-11	V6/4Cyl	3915020	Fits M5od Transmission
Thunderbird	83-91	V6/V8	3915031	Fits Stock Knob Only
MERCURY				
Cougar	83-91	V6/V8	3915031	Fits Stock Knob Only
PONTIAC				
Firebird	93-02	V8	3915060	Fits Stock Knob Only
Firebird	93-02	V8	3915061	Chrome Stick & Black Knob Only
Firebird	83-92	V8	3915032	
Firebird	83-02	V6	3915032	
G8	2009	V8	3916030	
GTO	04-06	V8	3915065	

BILLET/PLUS[®]

Chevrolet Camaro



3916031 • 16-17 CAMARO SS

CHROME STICK W/ WHITE SHIFT KNOB

The heritage of Hurst is now available for the new breed of Chevy's Camaro SS with this new Billet/Plus 6-speed performance shifter. Designed to put the "feel of performance" back into shifting, this quality crafted precision shifter is a must for the serious Camaro performance enthusiast. This shifter features Hurst's classic and iconic white shift knob for that old-school muscle car look while maintaining modern performance.

3916131 • 16-17 CAMARO SS

BLACK PISTOL GRIP FOR MODERN LOOK

Hurst introduces a new version of their popular Billet/Plus shifter for the 2016 Chevy Camaro SS with the 6 speed manual transmission. This shifter has all of the same performance benefits of the classic version, but now adds a black pistol grip style handle, similar to the Nitro Stick. This adds a modern look to a classic design for these cars, or the customer can choose to retain the OEM stick with this shifter.



3916034 • 16-17 CAMARO LT

REDUCED SHIFT THROW BY 40%

Hurst introduces a new version of their popular Billet/Plus shifter for the 2016 Camaro LT with the TR3160 6-speed manual transmission. This shifter has all of the same performance benefits of the classic version, like a 40% reduction in shifter throw, but now adds a black pistol grip style handle, similar to the Nitro Stick. This adds a modern look to a classic design and is backed by Hurst's Lifetime Limited Warranty.



BILLET/PLUS[®]

Chevrolet Camaro



3916030 • 10-15 CAMARO

REDUCED SHIFT THROW BY OVER 44%

From concept through production of the 5th generation Camaro, GM engineers in both Australia and Detroit were in almost daily contact with Hurst engineers for guidance and design support. Stout Tremec TR-6060 and little brother, Aisin Warner AY6, transmissions were sent thousands of miles across the Pacific for testing and evaluation in conjunction with prototype shifters. Secretive track and laboratory testing, including GM's brutal GMN2893 endurance tests, were run to ensure that this Hurst Shifter was the best. That's why you had the option to get Hurst Shifter in a Camaro installed at the factory. If you didn't – don't worry. Hurst engineers used all of that knowledge and made the aftermarket version even better.

FEATURES & BENEFITS

- » CNC-Machined, 6061-T6 Billet Aluminum Pivot Housing
- » Heat-Treated, Billet Steel Gear Selector Shaft and Bushing Housing for Ultimate Strength
- » High-Strength, Chrome-Plated Steel Upper Stick - Not a Casting
- » Teflon Lined Spherical Bearing Main Pivot Ensures Smooth Shifting and Reduced Wear
- » Direct-Link, Full-Race, Isolation-Eliminating Design for a No-Compromise Positive Shift
- » Optional Isolation System Included Reduces Stick Vibration and Noise Transfer
- » Reduced Shift Throw by Over 44%
- » Improved, Glass-Filled, Teflon Lower Bushing with Greater Stability and Strength
- » Includes White, Hurst 6-Speed Knob (V6 Pattern Available Separately)



BILLET/PLUS[®]

Chevrolet Camaro / Pontiac Firebird

3915061 • 93-02 CAMARO & FIREBIRD

REDUCED SHIFT THROW BY OVER 30%

When the designers and engineers at GM need help with improved performance shifting in their newest concepts they turn to Hurst. From the GTO and Camaro models in the 1960s through today's modern Camaros, GM works directly with Hurst engineers to help improve shifting in their vehicles. That's something only a company with over 55 years of shifter design experience can provide. The shifters in the 4th generation Camaro & Firebird were no different. Hurst was tasked with creating a performance shifter that could be an option and installed in the factory. Of course the OEMs have to design for every possible driver – this shifter is that factory shifter with no compromises and the classic Hurst style. Includes black Hurst 6-speed knob.

3915060 • 93-02 CAMARO & FIREBIRD

RETAINS FACTORY KNOB & INTERIOR STYLING

FEATURES & BENEFITS

- » Self-Centering Alignment for Improved 2nd to 3rd Upshift Gear Changes
- » Stainless Steel Rotating Pivot Ensures Smooth Shifting and Reduced Wear
- » Two Piece, Bolt-On Upper Stick Allows the Install of any Hurst Upper Stick
- » Adjustable Positive Gear Stops to Help Prevent Internal Transmission Damage
- » Exclusive Oil Control Seal Eliminates Transmission Fluid Loss and Contamination
- » High-Strength, Chrome-Plated Steel Upper Stick
- » CNC-Machined, 6061-T6 Billet Aluminum Base and Stop Collar
- » Polyamide Pivot Cup Reduces Stick Vibration and Noise Transfer



BILLET/PLUS[®]

Chevrolet Corvette

3915086 • 05-13 C6 CORVETTE

REDUCED SHIFT THROW BY OVER 25%

Hurst Billet/Plus Shifters incorporate a high ratio pivot mechanism for reduced shifter throw and are sturdily constructed for a more positive precise feel when shifting. Self centering alignment improves 2nd to 3rd up-shift gear changes to reduce the chance of "missed shifts". Patented adjustable bias spring loads on most models allow stick tension to be tailored to drivers preference. Dedicated applications assure a custom fit and eliminate any vehicle modifications for ease of installation. Note: may not fit stock knob on some models.

FEATURES & BENEFITS

- » Adjustable, Positive Gear Stops to Help Prevent Internal Transmission Damage
- » Polyamide Pivot Cup Retains Centering Spring Assembly for Increased Centering Force
- » Patented (US Patent no. 4,581,951) Adjustable-Bias Spring-Load for Ease of Operation
- » Self-Centering Alignment for Improved 2nd to 3rd Upshift Gear Changes
- » Stainless Steel Rotating Pivot Ensures Smooth Shifting and Reduced Wear
- » Threaded Handle Designed to Fit Original Knob for a Stock Factory Look
- » CNC-Machined, 6061-T6 Billet Aluminum Base and Top Plate
- » Reduced Shift Throw by Over 25%

3915085 • 97-04 C-5 CORVETTE

REDUCED SHIFT THROW BY OVER 25%

COMING SOON • 14-17 C-7 CORVETTE



BILLET/PLUS®

Pontiac G8 / GTO

3916030 • 2009 G8 GXP

REDUCED SHIFT THROW BY OVER 44%

- » CNC-Machined, 6061-T6 Billet Aluminum Pivot Housing
- » Heat-Treated Billet Steel Gear Selector Shaft and Bushing Housing for Ultimate Strength
- » High-Strength, Chrome-Plated Steel Upper Stick - Not a Casting
- » Teflon Lined Spherical Bearing Main Pivot Ensures Smooth Shifting and Reduced Wear
- » Direct-Link, Full-Race, Isolation-Eliminating Design for a No-Compromise Positive Shift
- » Optional Isolation System Reduces Stick Vibration and Noise Transfer
- » Reduced Shift Throw by Over 44%
- » Improved, Glass-Filled, Teflon Lower Bushing with Greater Stability and Strength
- » Includes White Hurst 6-Speed Knob

3915065 • 04-06 GTO

REDUCED SHIFT THROW BY OVER 30%

The heritage of Hurst is now available for the latest breed of Pontiac GTO with this new Billet/Plus 6-speed performance shifter. Designed to put the “feel of performance” back into shifting, this quality crafted precision shifter is a must for the serious GTO performance enthusiast.

FEATURES & BENEFITS

- » Spherical Pivot Bearing
- » Chrome Stick & Classic Black Knob
- » Unique Link-Bar Pivot System Retains Remote Actuation
- » Additional Upper Stick Included that Accepts Factory Knob
- » CNC-Machined Billet 6061-T6 Mil-Spec Anodized Aluminum Pivot Base
- » Reduced Shift Throw by Over 30%



BILLET/PLUS[®]

Dodge Challenger

3916020 • 09-16 CHALLENGER

CLASSIC CHROME STICK W/ WHITE SHIFT KNOB

Prior to Dodge releasing the manual version of the Challenger, the executives and engineers in the SRT division turned to Hurst for a suitable performance shifter option. They knew that Hurst designed the original pistol grip shifter that was in the Challengers of the 1970s and who better to offer guidance on these new vehicles than Hurst? Well before the first modern-day Challengers officially hit the streets, a flat black prototype manual Challenger, along with mountains of CAD and testing data, was sent to Hurst for evaluation and testing. Equipped with a one-off prototype front bumper and a stealth-like skin, this car was fitted with prototype after prototype and then tested on the streets, in the canyons, and around the race tracks of Southern California. Months of field and durability testing resulted in the shifter offered today: a masterpiece of over 20 design iterations and improvements.

3916120 • 09-16 CHALLENGER

BLACK PISTOL GRIP HANDLE FOR MODERN LOOK

FEATURES & BENEFITS

- » CNC-Machined, 6061-T6 Billet Aluminum Carrier
- » Billet Stainless Steel Adapter Block Allows Stock Handle/Stick or any Hurst Upper Stick
- » High-Strength, Chrome-Plated Steel Upper Stick - Not a Casting
- » Teflon Lined Spherical Bearing Main Pivot Ensures Smooth Shifting and Reduced Wear
- » Heat-Treated Billet Chrome-Moly Gear Selector for Ultimate Strength
- » E-Coated Stainless Steel Adapter Block and Rear Bushing Housing
- » Full Isolation Design and Urethane Mounting Bushings
- » Reduced Shift Throw by Over 30%





BILLET/PLUS[®]

Ford Mustang



3910204 • 11-14 MUSTANG

REDUCED SHIFT THROW BY OVER 30%

The 2011-2014 Ford Mustang packs a punch! And Hurst's Billet/Plus shifter for the 2011-2014 Mustang GT/Boss/V6 packs a whopping 30% throw reduction and improves upon the mighty Ford driveline with a new billet aluminum base housing and a spherical pivot bearing. Two piece, bolt-on upper stick will accept any Hurst stick with a two-bolt pattern. A redesigned, spring loaded reverse lock-out improves factory "push down" lock-out detent design. Simple to install with classic Hurst stick and white 6-speed knob combination, this is the MUST HAVE companion to your 2011 - 2014 Mustang.

FEATURES & BENEFITS

- » CNC-Machined, 6061-T6 Billet Aluminum Shifter Housing
- » High-Strength, Chrome-Plated Steel Upper Stick - Not a Casting
- » Solid Plate Steel Base Construction
- » E-Coated, Billet Steel Gear Selector for Ultimate Strength
- » Polyamide (PA 6/6) Pivot Cup and Delrin® Support Ring Reduces Vibration and Noise
- » Subtle, but Effective, LED Reverse Gear Engagement Indicator
- » Reduced Shift Throw by Over 30%





BILLET/PLUS[®]

Ford Mustang

3915201 • 05-10 MUSTANG

REDUCED SHIFT THROW BY OVER 30%

With the success of other Hurst Billet/Plus Shifters in other modern muscle car applications, the Hurst engineers went back to the drawing board to update, advance, and apply what they had learned. The pony car that started it all in the sixties and once again re-started the retro-muscle-car movement in 2004 & 2005. The very retro and very cool Mustang GT needed to have the very best Hurst has to offer: the Hurst Billet/Plus Shifter. Like nothing else, the Hurst Billet/Plus Shifter harkens back to the Mustangs that started it all. With adjustable shift stops and a high-strength steel stick, this shifter will get you through the gears and down the rack in short order with all the style, class, and heritage only Hurst can supply.

FEATURES & BENEFITS

- » CNC-Machined Mil-Spec Anodized 6061-T6 Aluminum Carrier and Pivot Housing
- » Smooth, Precise Teflon[®] Lined Steel Spherical Bearing
- » Solid, Positive, and Quick Shift Throws that are Reduced by Over 30%
- » High Durometer Polyurethane Bushings Front and Rear for a Solid and Sturdy Shifting Platform
- » Classic Interchangeable Hurst Chrome Stick and White Knob

3915035 • 01-04 MUSTANG

REDUCED SHIFT THROW BY OVER 35%

This Hurst Billet/Plus Shifter incorporates a high ratio pivot mechanism for reduced shifter throw and is sturdily constructed for a more positive precise feel when shifting. Self centering alignment improves 2nd to 3rd up-shift gear changes to reduce the chance of "missed shifts". Patented, adjustable bias spring loads allow stick tension to be tailored to the driver's preference. Direct bolt-in replacement ensures a custom fit and eliminates any vehicle modifications for ease of installation and accepts factory knobs.

FEATURES & BENEFITS

- » CNC-Machined, 6061-T6 Billet Aluminum Base and Stop Collar
- » Heat-Treated, Billet Steel Gear Selector for Ultimate Strength
- » Adjustable Positive Gear Stops to Help Prevent Internal Transmission Damage
- » Stainless Steel Rotating Pivot Ensures Smooth Shifting and Reduced Wear



BILLET/PLUS[®]

Mustang / T-Bird / Cougar / Ranger



3915033 • 83-01 MUSTANG

REDUCED SHIFT THROW BY OVER 30%

Get all the benefits of Hurst's modern Billet/Plus Shifter for your SN-95 Mustang AND get classic Hurst looks. The flat, chrome Hurst stick and white Hurst 5-speed knob command the T-45 or T-5 through the gears with a crisp, clean "snap" that only a Hurst shifter can provide. Solid shift feel, positive gear engagement, and quick smooth shifting... that's what a Hurst shifter is all about! Includes white Hurst 5-speed knob

3915031 • 83-01 MUSTANG, 83-91 THUNDERBIRD/COUGAR

REDUCED SHIFT THROW BY OVER 30%

This shifter provides top race teams and racers with a no-compromise direct link to the transmission. Smooth, slick shifting with complete and positive gear engagement makes driving not only more enjoyable but will improve lap/track times. For all of those hot rod and custom builders out there who are using a T-45 or T-5 out of a donor Mustang – this shifter is the perfect choice. This shifter will work beautifully with any of the Hurst bolt-on upper sticks listed in the back of this catalog – all thanks to the standard Hurst "stub-stick" bolt-on design.



3915020 • 88-11 RANGER

REDUCED SHIFT THROW BY OVER 25%

Let's face it: the Ford Ranger is a whole lot of truck for the money – but the shifter could use some help. The Hurst engineers didn't cut any corners on this one. It has all the same materials, construction, and features that go into a high-dollar supercar shifter, along with the classic Hurst look of the flat chrome stick, floor mounted boot, and black Hurst 5-speed knob.

FEATURES & BENEFITS

- » CNC-Machined, 6061-T6 Billet Aluminum Base and Stop Collar (3915033 & 3915031) or Top Plate (3915020)
- » Heat-Treated, Billet Steel Gear Selector for Ultimate Strength
- » High-Strength, Chrome-Plated Steel Upper Stick - Not a Casting
- » Stainless Steel Rotating Pivot Ensures Smooth Shifting and Reduced Wear
- » Polyamide Pivot Cup Retains Centering Spring Assembly for Increased Centering Force
- » Self-Centering Alignment for Improved 2nd to 3rd Upshift Gear Changes
- » Exclusive Oil Control Seal Eliminates Transmission Fluid Loss and Protects from Contamination





COMPETITION/PLUS®

Manual Shifters

Competition/Plus – The benchmark of transmission control since 1965. Such a solid design from its inception, the Competition Plus shifter you can buy today is built from the same drawings, tooling design, and material specifications as it was over 50 years ago. With a wide array of custom applications, these shifters will bolt into OEM consoles with no modifications required. Designed for short, precise throws between gears, the Competition/Plus provides unparalleled shift quality and feel. Every Competition/Plus shifter can be paired with Hurst's heat-treated linkage rods and arms (Installation Kit) for track-worthy durability. Adjustable shift stops help prevent overshifts and possible transmission damage. Features such as the chrome-plated stick and classic white Hurst shift knob assure the fit and finish are up to the standards of any car in which this shifter might be installed.

Applications

BUICK	YEAR	DESCRIPTION	TRANSMISSION	SHIFTER	INST. KIT
Grand Sport	66-67	With and without console	Saginaw (441)	3917307	3734297
	65	With and without console	Muncie (451)	3917308	3733163
Skylark	65	With and without console	Muncie (451)	3917308	3733163
Special	66-67	With and without console	Saginaw (441)	3197307	3734297
CHEVROLET					
Full Size	63-64	With and without console	Muncie (451)	3917308	3733163
	60-63	With and without console	BW T-10 (410)	3917308	3734734
	58-59	All	BW T-10 (410)	3917307	3733157
	55-57	All	BW T-10 (410)	3913780	3734734
			Richmond/BW T-10 (454)	3913780	3738609
			Muncie (452/453)	3913780	3737834
			Saginaw (441)	3913780	3737919
			Muncie (451)	3913780	3733163
Camaro	74-81	Without console	Richmond/BW T-10 (454)	3918794	3738609
		With console	Richmond/BW T-10 (454)	3918791	3738609
	73-77	With console	Saginaw (441)	3917438	3738607
	73-74	With console	Muncie (453)	3918791	3738605
	70-72	With and without console	Muncie (453)	3916848	3737897
	69	With and without console	Muncie (452)	3917438	3737437
	67-68	With and without console	Saginaw (441)	3914339	3734531
			Muncie (451)	3914339	3734529
Chevelle & Malibu	73-74	With and without console	Muncie (453)	3916848	3737897
	69-72	With and without console	Muncie (452/453)	3918014	3737834
	68	With and without console	Muncie (451)	3918014	3733163
	66-67	With and without console	Saginaw (441)	3917307	3734297
	64-67	With and without console	Muncie (451)	3917308	3733163
Chevy II & Nova	71-73	Without console	Muncie (453)	3916848	3737834
	69-70	Without console	Muncie (452)	3916848	3737131
	68	With console	Muncie (451)	3914339	3734529
	68	Without console	Muncie (451)	3916848	3734529
	65-67	With and without console	Muncie (451)	3917308	3734354
	64	With and without console	Muncie (451)	3917308	3733163

*Modification to stick may be necessary to clear seat

COMPETITION/PLUS®

Applications

CHEVROLET (CONT.)	YEAR	DESCRIPTION	TRANSMISSION	SHIFTER	INST. KIT
Corvette	69-79	All	Muncie & BW (452/453 & 454)	3917992	3738611
	68	All	Muncie (451)	3917992	3734648
	63-67	All	Muncie (451)	3917960	3733162
	57-62	All	BW T-10 (410)	3917535	3733157
El Camino	69-72	With and without console	Muncie (452/453)	3918014	3737834
	68-72	With and without console	Saginaw (441)	- - - -	3737919
	68	With and without console	Muncie (451)	3918014	3733163
	66-67	With and without console	Saginaw (441)	3917307	3734297
	64-67	With and without console	Muncie (451)	3917308	3733163
	59	All	BW T-10 (410)	3917307	3733157
Monte Carlo	78-80	With and without console	Saginaw (441)	3918794	- - - -
	74	With console	Muncie (453)	3916848	3737897
	70-72	With and without console	Muncie (452/453)	3918014	3737834
1/2 Ton Chev /GMC Pickups		Custom install on passenger car trans.	Muncie (451)	3910002	3733163*
		Custom install on passenger car trans.	Muncie (452/453)	3910002	3737834*
			Richmond/BW T-10 (454)	3910002	3738609*
			BW T-10 (410)	3910002	3734734*
			Saginaw (441)	3910001	3737919*
CHRYSLER					
Full Size	66-67	With console	New Process (422)	3916790	3734089
	64-67	Without console	New Process (422)	- - - -	3734089
DODGE					
Charger	66-72	Without console	New Process (422)	3916789	3734089
	66-69	With console	New Process (422)	3916790	3734089
Coronet & Super Bee	65-72	With console	New Process (422)	3916789	3734089
	65-69	With console	New Process (422)	3916790	3734089
Full Size	65-69	With console	New Process (422)	3916790	3734089
Fairlane & Torino	72-73	With and without console	Ford T & C (433)	3913180	3735587
	70-71	With and without console	Ford T & C (433)	3913180	3737638
	66-69	With and without console	Ford T & C (433)	3913180	3737638
Falcon	66-67	8 Cyl. With and without console	Ford T & C (433)	3913180	3737638
Mustang	15-16	V8, V6, 4 Cyl. Ecoboost with console	Getrag MT82	3910205	- - - - -
	05-10	V8 with console	Tremec TR-3650	3910201	- - - - -
	87-92	With and without console	BW T-5 (465)	5380036	- - - - -
	70-73	302, 351 V-8			
		With and without console	Ford T & C (432)	3913180	3737637
	67-69	390, 428, 429 V-8			
		With and without console	Ford T & C (433)	3913180	3735587
	65-69	289, 302, 351 V-8			
		With and without console	Ford T & C (432)	3913180	3737637
Shelby Mustang GT-500	67-69	With and without console	FORD T & C (433)	3913180	3735587
Shelby Mustang GT-350	65-69	With and without console	BW T-10 (413)	3913180	- - - - -

*Modification to stick may be necessary to clear seat

COMPETITION/PLUS®

Applications

FORD (CONT.)	YEAR	DESCRIPTION	TRANSMISSION	SHIFTER	INST. KIT
Ranchero	72-73	6 & 8 Cylinder			
		With and without console	Ford T & C (433)	3913180	3735587
	70-71	With and without console	Ford T & C (433)	3913180	3737638
	66-69	8 Cyl. with and without console	Ford T & C (433)	3913180	3737638
MERCURY					
Comet & Cyclone	66-69	With and without console	Ford T & C (433)	3913180	3737638
Cougar	67-69	289, 302, 351 V-8 with or without console	Ford T & C (432)	3913180	3737637
	67-69	390, 428, 429 V-8 with or without console	Ford T & C (433)	3913180	3735587
OLDSMOBILE					
F-85	66	Without console	Muncie (451)	3917308	3733163
	64-65	With and without console	Muncie (451)	3917308	3733163
442	78-79	With and without console	Saginaw (441)	3918794	-----
	66	Without console	Muncie (451)	3917308	3733163
	64-65	With and without console	Muncie (451)	3917308	3733163
Cutlass	78-79	With and without console	Saginaw (441)	3918794	-----
Belvedere & GTX	65-72	Without console	New Process (422)	3916789	3734089
Roadrunner	68-72	Without console	New Process (422)	3916789	3734089
PONTIAC					
Full Size	60-64	Without console	BW T-10 (410)	3917308	3734734
Firebird	74-81	With console	BW T-10 (454)	3918791	3738609
	74-81	Without console	BW T-10 (454)	3918794	3738609
	70-72	With and without console	Muncie (452/453)	3916848	3737897
	69	With and without console	Muncie (452)	3917438	3737437
	67-68	With and without console	Saginaw (441)	3914339	3734531
	67-68	With and without console	Muncie (451)	3914339	3734529
Grand Prix	78-79	With and without console	Saginaw (441)	3918794	-----
G.T.O	64-66	Without console	Muncie (451)	3917308	3733163
Tempest & Le Mans	78-79	With and without console	Saginaw (441)	3918794	-----
	66	Without console	Saginaw (441)	3914339	3734531
	64-66	Without console	Muncie (451)	3917308	3733163
Ventura II	71-73	Without console	Muncie (453)	3916848	3737834
STUDEBAKER					
Hawk	59-64	With Bucket Seats	BW T-10 (410)	3917308	3734734

*Modification to stick may be necessary to clear seat

REMOVE BEE

COMPETITION/PLUS®

5 & 6-Speed Manual Shifters

CLASSIC WHITE SHIFT KNOB

FLAT-BLADE BOLT-ON STICK

Chrome-Plated Steel

PULL-UP CHROME-PLATED TRIGGER ROD

FACTORY BOOT ATTACHMENT POINT

GUIDE NUT

Helps Guide the Collar in Relation to the Stick

REVERSE LOCK-OUT COLLAR

Prevents the Chance of Accidentally Going into Reverse

LOWER STICK

4140 Alloy with Black E-Coat

IGUS BEARINGS

Prevents Wear Between Moving Parts, Lubrication Free

SHIFT ROD

Zinc-Plated Steel

STAMPED LINKS

Zinc-Plated ASTM A-570 Steel

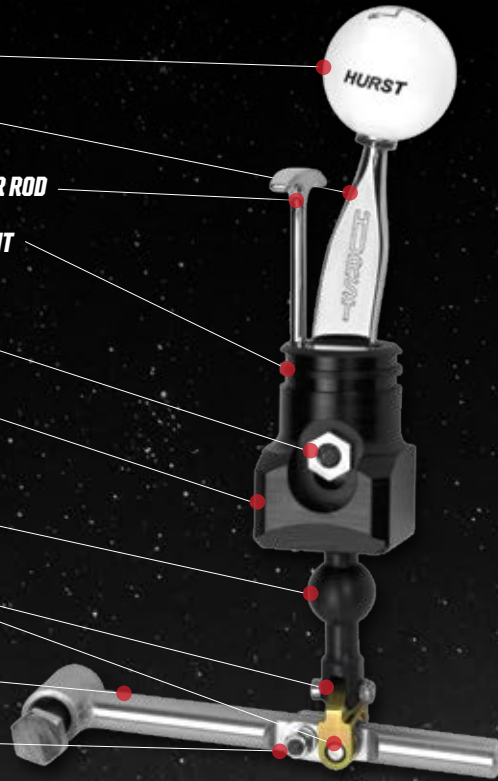

3910205 • 15-16 MUSTANG

The latest Mustang not only looks great, but now handles even better. It is just as appropriate that the Hurst Competition Plus Short Shifter for the 15-16 Mustang GT functions even better as well.

This new Hurst shifter utilizes a multi-link-type mechanism that allows 38% throw reduction while maintaining factory geometry, alignment, and side-to-side resolution. Positioned in-line with the classic Hurst chrome plated flat blade stick is a chrome plated trigger rod. This trigger rod not only functions as part of the reverse lockout feature, but truly adds style points to the interior.

3910201 • 05-10 MUSTANG

The Hurst Competition Plus shifter for your 2005-2010 Mustang reduces shift throw by 30%. Features include a spherical pivot bearing, urethane bushings front and rear, chrome stick and white knob.

- » High Ratio Pivot Mechanism
- » Chrome Plated Steel Bolt On Stick
- » No Modifications Necessary
- » Easy Installation



COMPETITION/PLUS[®]

4-Speed Manual Shifters



3910002



3913180



3918014



3913780



3918794



3914339



3916790



3916848



3917307



3917308



3917960



3917992



3917535



3918791



3917438

2017 Hurst Kenne Bell R-Code Mustang by GSS Supercars





STREET SUPER SHIFTER™

4-Speed Manual Shifters

ABOUT STREET SUPER SHIFTERS

Based on the racing version of the legendary Super Shifter 3, using the straightforward, logical engineering for which Hurst is famous for. The result is the ultimate in performance, feel, dependability, and value. The Street Super Shifter comes complete with all necessary hardware and an easy-to-follow installation guide. PLEASE NOTE: These shifters are not vehicle specific, therefore stock consoles cannot be used, and minor floor pan modifications are generally required.

MORE POSITIVE SHIFTS >> High-Mounting Design Allows Linkage to Run Level & Straight, Making the Assembly Stronger

FOR A SHORT THROW >> 7-1/2" Tall Chrome-Plated Stick & (3/8-16 Thread) 4-3/4" Knob Travel Between Gears

RACE-LEVEL SPECIFICATIONS >> On Materials & Heat-Treatment Ensure Highest-Quality Assembly

PREVENT OVERSHIFTS >> With Adjustable Gear Stops

TRANSMISSION	SHIFTER	INST. KIT
Muncie (451,452,453)	3917535	3738616
BWT-10 (410)	3917535	3738616
Richmond / BW Super T-10 (454)	3917535	3738616
Saginaw (441)	3917535	3738618
Ford T&C (432,433)	3917535	3738615

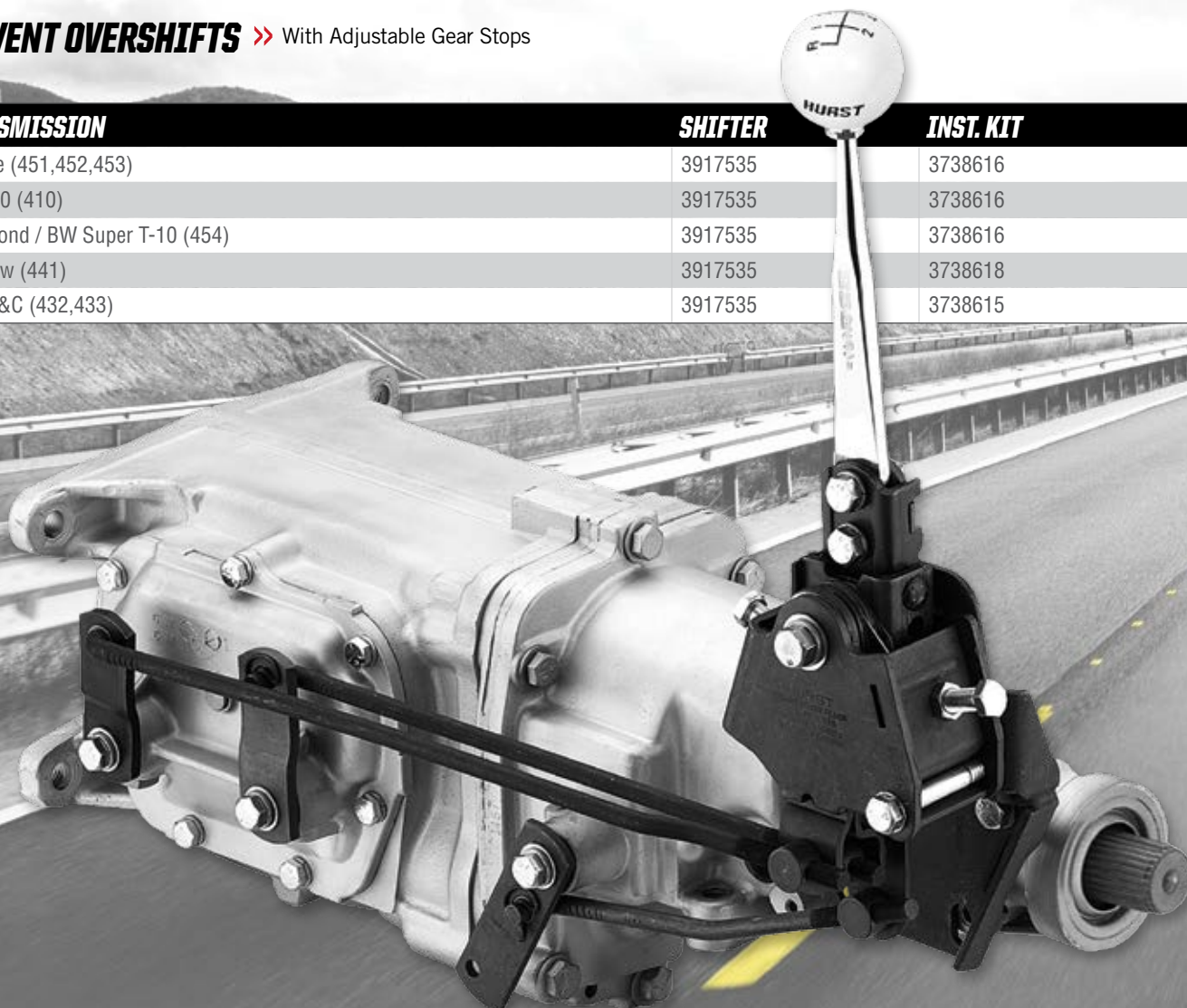

MASTERSHIFT™

3-Speed Manual Shifters

ABOUT MASTERSHIFT SHIFTERS

Hurst Mastershift – Timeless innovation and quality. Production of the original Hurst 3-speed shifter started in Glenside, Pennsylvania in late July of 1960. The Mastershift is built to the same strict quality standards of the Hurst 4-speed line. These shifters are still popular as both replacement floor shifters and column shift conversions.

BUICK	YEAR	DESCRIPTION	TRANSMISSION	SHIFTER	INST. KIT
Gran Sport/Special	66-67	6 & 8 Cylinder w/out console	Saginaw (343)	3667271	3670010
CHEVROLET					
Chevelle	66-74	6 & 8 Cylinder w/out console	Saginaw (343)	3667271	3670010
Truck	69-87	All 1/2 & 3/4 ton 2WD, Blazer, Suburban	Saginaw (343)/ Muncie (351)	3666809	3670006
FORD					
Bronco	66-77	8 Cylinder Only	Ford T & C (333)	3666901	-----
Pick-Up 1/2 Ton	63-87	All 2 Wheel Drive*	Ford (333)	3666809	3670027
Mustang	65-73	289, 302,351, V8 w/ console	Ford T & C (336)	3663179	3677640
Mustang	65-73	6 Cyl. w/ or w/out console	Ford (336/337)	3663179	3677640
MERCURY					
Cougar	67-69	289, 302,351 & V8 w/ or w/out console	Ford T & C (336)	3663179	3677640
Meteor	1963	8 Cyl. w/out console	Ford T & C (333)	3663179	3677640
OLDSMOBILE					
Cutlass F-85 & 442	66-72	6 & 8 Cyl. w/out console	Saginaw (343)	3667271	3670010

*Modification to catalytic converter bracket may be necessary if vehicle is so equipped

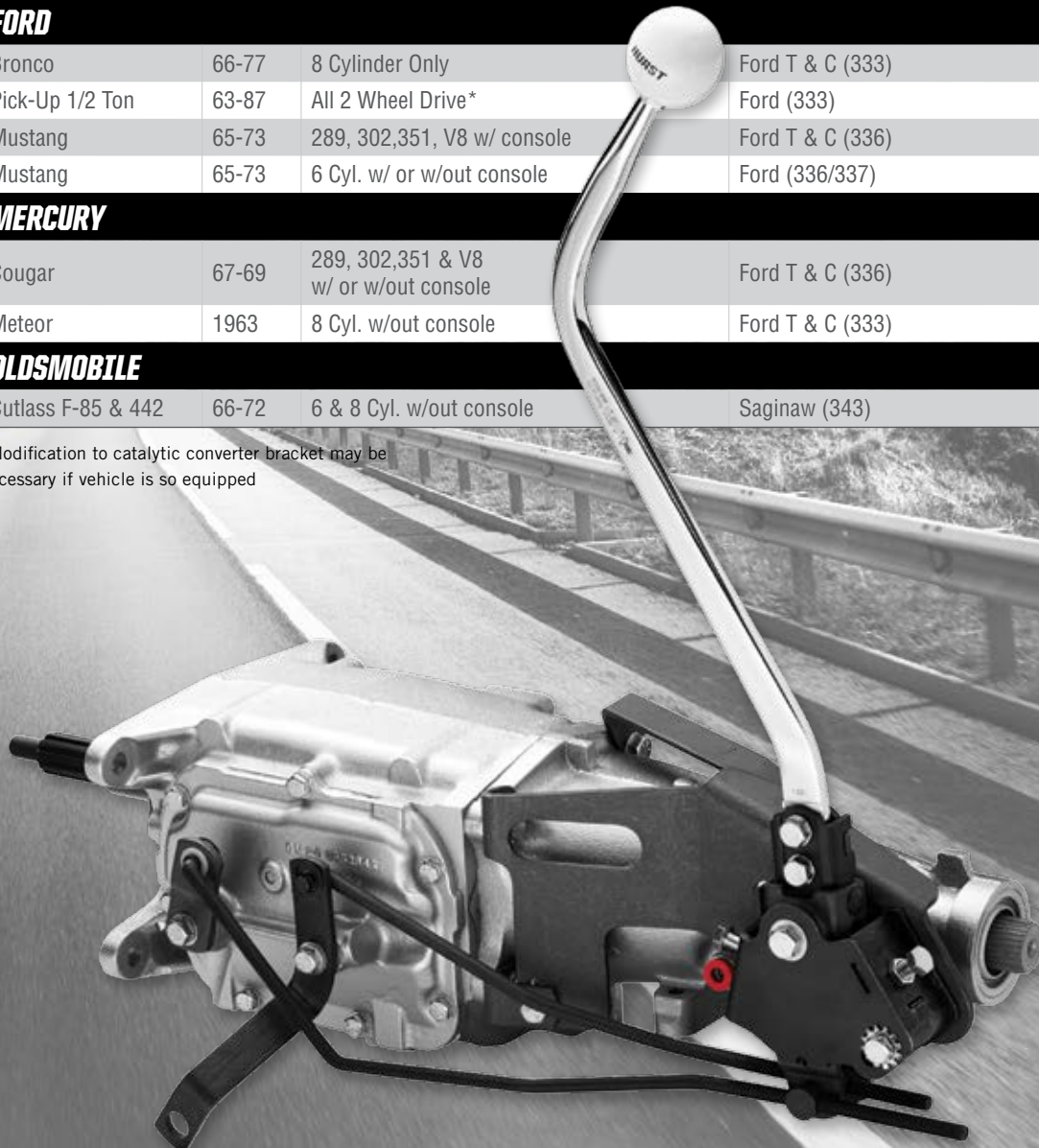

INDY SHIFTER®

6-Speed Manual Shifter

NEW!

3916036 • 15-16 MUSTANG

REDUCED SHIFT THROW BY 18%

Hurst introduces their new manual Indy shifter for 2015-2016 Ford Mustang models with MT-82 6-Speed transmission. This includes models with the 5.0L, 2.3L and 3.7L engines. As an Indy model, this shifter provides a noticeable amount of throw reduction and a firmer, crisper feel, all while retaining the factory reverse lockout collar and function. This shifter includes a replacement stick, reverse lockout slider, urethane rear mount and a classic black Hurst round ball knob. This Indy shifter is backed by a Lifetime Limited Warranty.

FEATURES & BENEFITS

- » CNC-Machined Billet Steel Parts
- » 18% Shift Throw Reduction
- » Classic Hurst Black Shift Knob
- » Accommodates Factory Reverse Lockout



INDY 6-SPEED SHIFTER

Ford Mustang (I4, V6 & V8 Models)

YEAR

15-16

PART

3916036

INDY SHIFTER[®]

3 & 4-Speed Manual Shifters



ABOUT HURST INDY UNIVERSAL SHIFTERS

Indy 3 and 4-speed shifters deliver quality components and accurate shifting at an incredible value. Do you have an older 3-speed pickup or car that could use some help when it comes to selecting gears? Or perhaps a 4-speed Muncie or Borg Warner T-10 and the shifting is feeling a little tired? These kits are for you. All kits come complete with required hardware, linkage, and easy-to-follow instructions. An Indy shifter kit will have you smoothly shifting and back to enjoying the ride in no time. The Indy 3-speed kits, used for both replacement shifters and column conversions, are engineered to fit specific transmissions, and can be adapted to many floor pans. Indy 4-speed kits: fitment for most popular vintage 4-speed transmissions: Muncie M-20, M-21, M-22, Borg Warner T-10, and Super T-10.

INDY UNIVERSAL 3-SPEED APPLICATIONS

	YEAR	PART #
Buick*	64 & Later	5010002
Chevrolet-Standard & H.D. 6 & 8 cylinder	55 & Later	5010002
Chevelle, Camaro, Chevy II	62 & Later	5010002
Oldsmobile-Standard & Intermediates*	49 & Later	5010002
Pontiac-Standard & H.D.*	58 & Later	5010002
Pontiac Firebird, Tempest & LeMans	64 & Later	5010002
Chrysler, Plymouth, Dodge Standard & Intermediate (except Duster, Demon, & Challenger - not for trucks)	57 & Later	5010002
Ford & Mercury Standard	49 & Later	5010002
Fairlane, Montego, Torino, Meteor, Falcon, & Comet	62 & Later	5010002

INDY PICKUP 3-SPEED APPLICATIONS (TALL)

All GM two-wheel drives with Saginaw, Muncie & Tremec Transmissions	69 & Later	5010016
All Ford two-wheel drives with Ford & Tremec Transmissions	63 & Later	5010016

INDY PICKUP 4-SPEED APPLICATIONS (SHORT)

Muncie (451, 452 & 453), BW T-10 (410, 454), Super T-10 AS3 & AS9		5030030
---	--	---------

*Will fit all 6 cyl., HD and standard 3-speed transmissions except selector type gear boxes (single shaft). Certain applications require a great deal of modification to make shifter fit.

NITRO STICKS™

For Hurst Manual Shifters



ILLUMINATING RED LED PRECISION SWITCH >> For Convenient Control of any Auxiliary Unit Including a Hurst Roll Control/Line Loc®, Transmission-Brake, and Nitrous

MILITARY SPEC. >> Clear or Black Anodized Finish with Engraved Hurst Logo

FIRM, NATURAL, COMFORTABLE >> Engineered to Provide a Firm, Natural, Comfortable Grip When Shifting

AEROSPACE QUALITY >> CNC-Machined 6061-T6 Aluminum Construction

Don't be afraid to push the **RED BUTTON!**

ABOUT HURST NITRO STICKS

After development of the Hurst Pistol-Grip Quarter Stick for automatic transmissions, the engineers at Hurst believed that the same style handle and durable switch should be available for those with manual transmissions. This time the switch was specified to be made completely out of aluminum for added strength, with an illuminating ring surrounding the button for added visibility, and a flip-cap design on the stick to avoid accidental activation of the auxiliary unit. The handle is CNC-machined from billet 6061-T6 aluminum for exceptional strength and is contoured just like the Quarter Stick Pistol-Grip for ergonomics. The precision switch has been chosen for its strength and durability, and is simply integrated at the top of the handle for convenient control of any auxiliary unit. Fits on any Hurst Competition/Plus or Billet Plus Shifter with standard 2-bolt connection.

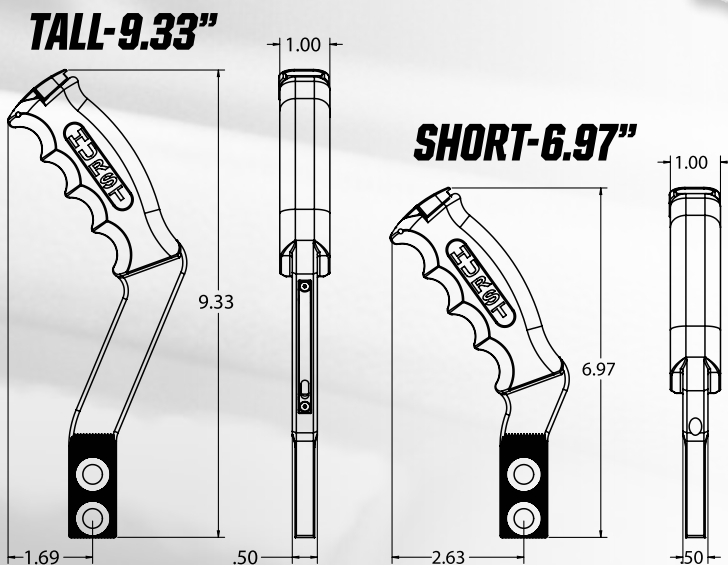

FINISH	SIZE	PART #
Black Anodized	Tall	5381001
Black Anodized	Short	5381101
Clear Aluminum Anodized	Tall	5381000

All Pistol-Grips include the following thread adapters
3/8-16, 1/2-20, M10-1.25, M10-1.50, M12-1.25, M12-1.75, M16-1.50

FLAT & ROUND BAR

Shifter Sticks

ABOUT HURST FLAT & ROUND BAR STICKS

Available in both round and flat bar styles, Hurst bolt on shifter sticks are ideal for use in custom applications where a particular height or offset is required. These shifter sticks are constructed from high strength, chrome plated steel and are stamped with the Hurst name and has 3/8 - 16 threads. Can be used on any Hurst two bolt style shifter assembly. Please refer to drawing/diagram for ideal application.



FLAT BAR STYLE

Shifter Sticks

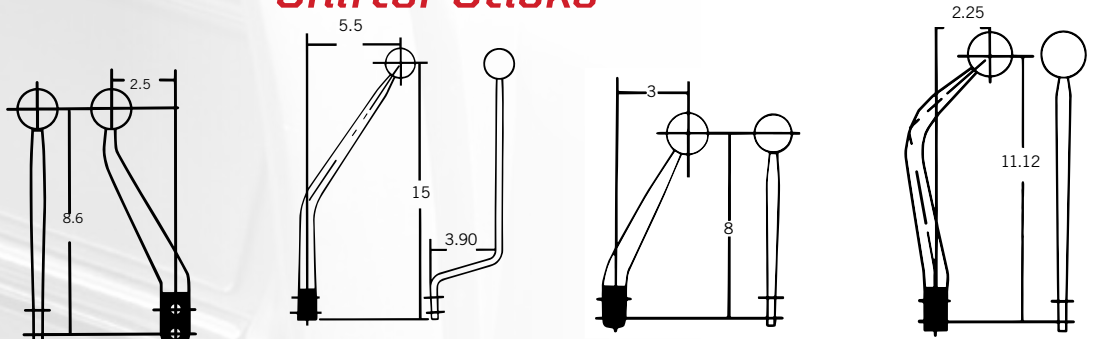

5388550

5384084
Used on shifter
3916790

5380015
Used on shifters
3918790, 3660005

5387236
Used on shifters
3917308, 3917307,
3917930, 3667271

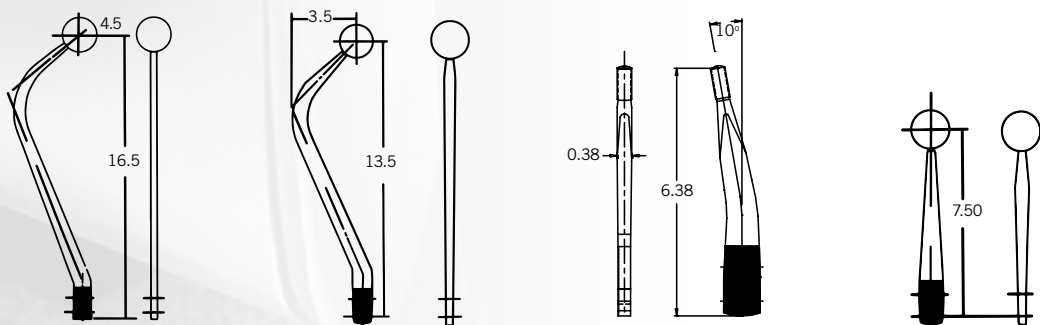

5384331
Used on shifters
3910002, 3666809

5386900
Used on shifters
3666901, 3918403,
3918404, 3915045

5387201
Used on shifters
3916030, 3915201,
3910204, 3910205

5387238
Used on shifters 3917535,
3915061, 3917960,
3916020

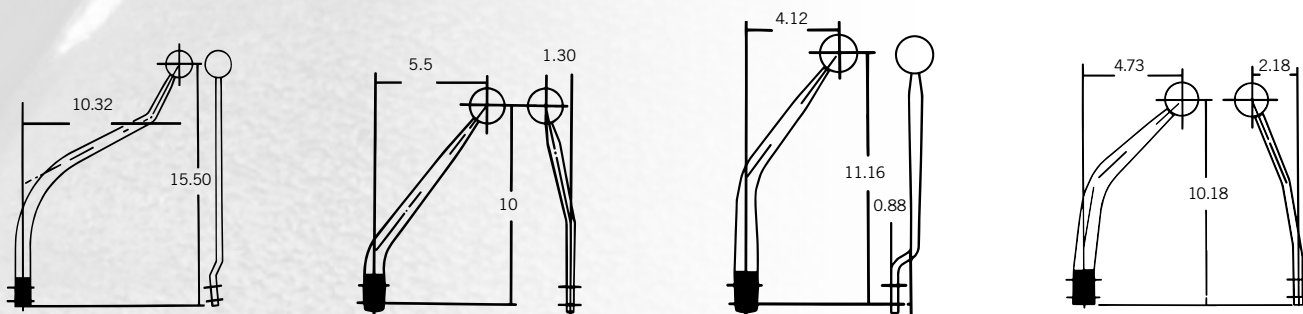

5384078
Used on shifter
3916789

5384106
Used on shifters 3914339,
3917879, 3664550

5386836
Used on shifters 3916822,
3917072, 3916848

5387436
Used on shifters
3917438, 3667954

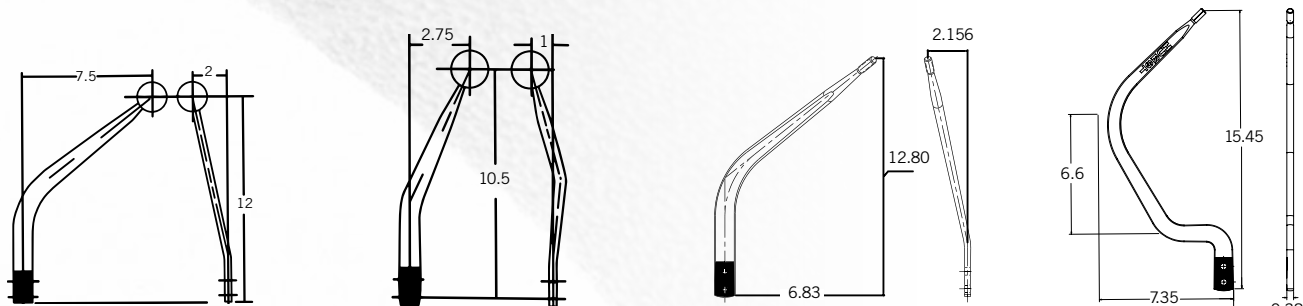

5388022
Used on shifter
3668034

5388009
Used on shifters 3918014,
3918791, 3918794

5380090

5388620
Bench seat stick for
custom installation

ROUND BAR STYLE

Shifter Sticks

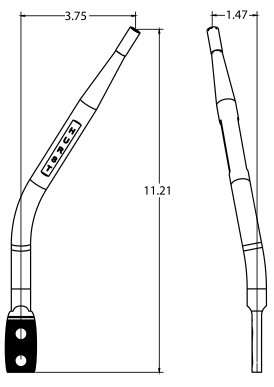
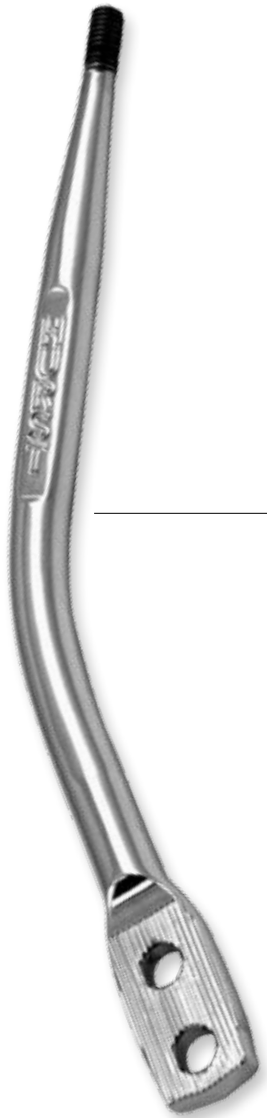

5387438
(Shown Left)

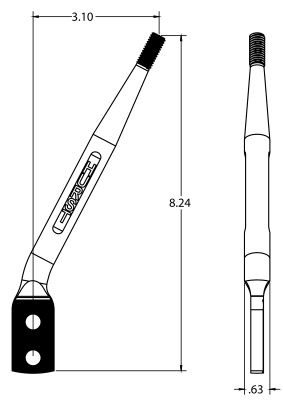

5389015

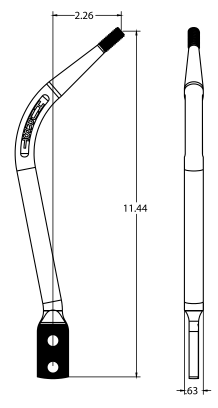

5389016

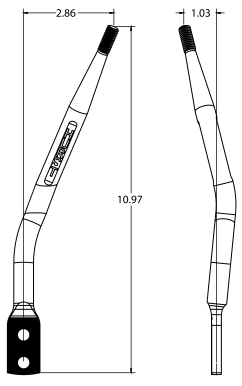

5389017



COMP STICK KIT • PART #5380036
87-93 FORD MUSTANG WITH T-5 MANUAL TRANSMISSION

The Comp Stick Kit fits the stock OEM shifter mechanism and aftermarket Hurst Competition Plus shifter mechanism. Kit consists of a white shift knob with gear shift pattern, chrome-plated flat shifter stick, rubber vibration isolator, shifter boot, and console top plate with the famous Hurst shifter logo.



PISTOL-GRIP™

Shifter Sticks

ABOUT HURST PISTOL-GRIP STICKS

From an original Challenger or Barracuda equipped with a Hurst Competition/Plus to a modern, brand-new Challenger equipped with a Hurst Billet/Plus, these handles just bolt on! In 1970, Chrysler introduced the Dodge Challenger and Plymouth Barracuda models with a must-have option: The Hurst Pistol-Grip Shifter. It became an iconic feature of the Dodge Challenger and Plymouth Barracuda, from the past all the way through today's new Challengers. Much of the same design and tooling that was used on the 1970 Challenger T/A & Plymouth 'Cuda AAR is used today to manufacture these reproduction Hurst Pistol-Grip handles and sticks. The same materials and construction methods are used but with one main difference – these reproduction handles incorporate Hurst's standard 2-bolt connection. These handles will fit on any Hurst aftermarket shifter that has a Hurst standard 2-bolt connection lower stick.

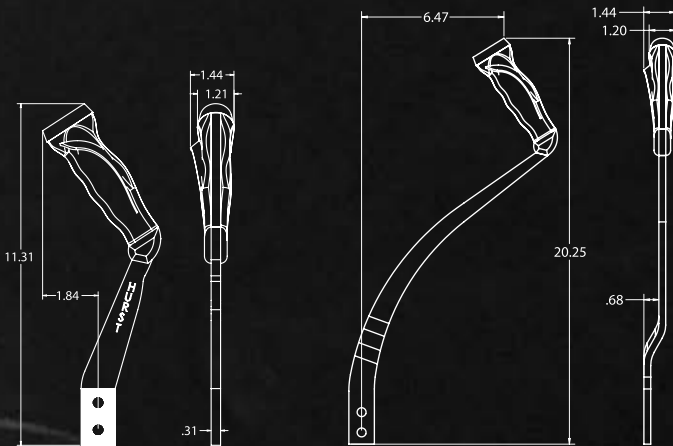

PART# 5388575

PART# 5388585

FOR CONSOLE AND NON-CONSOLE APPLICATION

ORIGINALLY DESIGNED FOR 70-74 'B' AND 'E' BODY MOPARS

IDEAL REPLACEMENTS >> Simulated Woodgrain Handle and Angled Lever are Ideal Replacements for Original Equipment

MOPAR 4-SPEED PATTERN >> Top of the Handle Features Mopar 4-Speed Pattern

CLASSIC HURST

Shifter Knobs

ABOUT CLASSIC HURST SHIFTER KNOBS

The classic look and feel of the Hurst shift knob is still at the top of its game. Available in a wide variety of patterns and thread sizes, these knobs are sure to work with your application. They are incredibly tough and feel great in the palm of your hand because they are built from the same material generally used by billiard ball manufacturers. Whether you are rowing through the gears at the track or short shifting through town, a Hurst shift knob will enhance your driving experience, one gear at a time.



» **1-3/4" DIAMETER (EXCEPT AS NOTED)**

» **MOULDED-IN-BRASS THREADED INSERT**

» **COMPLETE WITH JAM NUT**

» **SOLID, HIGH-GLOSS, HIGH-STRENGTH POLYMER**

CLASSIC SHIFTER KNOBS WITH HURST LOGO

THREAD SIZE	DESCRIPTION	PART #	DIAM.
3/8-16 Threads	4-Speed, White	1630003	1.75"
3/8-16 Threads	4-Speed, Black	1630103	1.75"
3/8-16 Threads	5-Speed, White	1630008	1.75"
3/8-16 Threads	5-Speed, Black	1630108	1.75"
3/8-16 Threads	6-Speed, White	1630040	1.75"
3/8-16 Threads	6-Speed, Black	1630140	1.75"
3/8-24 Threads	4-Speed, White	1630002	1.75"
7/16-20 Threads	5-Speed, Black	1630104	1.75"

CLASSIC SHIFTER KNOBS WITHOUT HURST LOGO

THREAD SIZE	DESCRIPTION	PART #	DIAM.
3/8-16 Threads	4-Speed, White	1630003	1.75"
3/8-16 Threads	4-Speed, Black	1630103	1.75"
3/8-16 Threads	5-Speed, White	1630008	1.75"
3/8-16 Threads	5-Speed, Black	1630108	1.75"
3/8-16 Threads	6-Speed, White	1630040	1.75"
3/8-16 Threads	6-Speed, Black	1630140	1.75"
3/8-24 Threads	4-Speed, White	1630002	1.75"
7/16-20 Threads	5-Speed, Black	1630104	1.75"
12mm x 1.75 Mustang	5-Speed, White	1630014	2.25"
12mm x 1.75 Mustang	5-Speed, Black	1630114	2.25"
16mmx1.5 Threads Camaro/Firebird	6-Speed, White	1630016	2.25"

SHIFTER BOOTS

For Hurst Shifters

INDY BOOT & PLATE • PART #1148429

A popular economy boot.
Complete with chrome trim plate & mounting hardware.
Measures 5-1/4" x 6-1/2" - 4 pleats



B-4 BOOT & PLATE • PART #1144580

Our most popular boot is adaptable to most shifter installations.
Complete with chrome trim plate & mounting hardware.
Measures 5-1/4" x 6-1/2" - 4 pleats

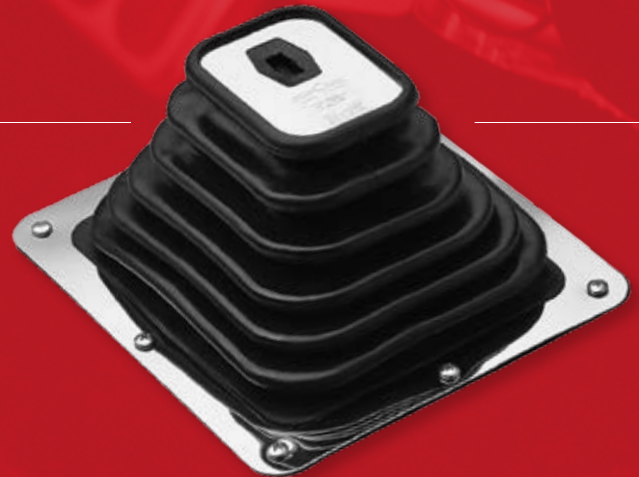

SUPER BOOT & PLATE • PART #1147494

Designed for large-hole shifter installations.
Complete with chrome ID plate & mounting hardware.
Measures 7-3/4" x 8-3/4" - 6 pleats

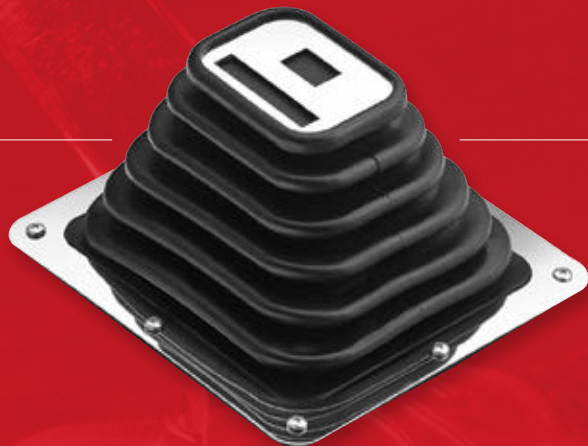

SUPER/SHIFTER 3 BOOT & PLATE • PART #1140010

Specially designed for use with Super/Shifter 3 utilizing separate reverse Loc/Out lever. Complete with chrome trim plate & mounting hardware.

Measures 7-3/4" x 8-3/4" - 6 pleats

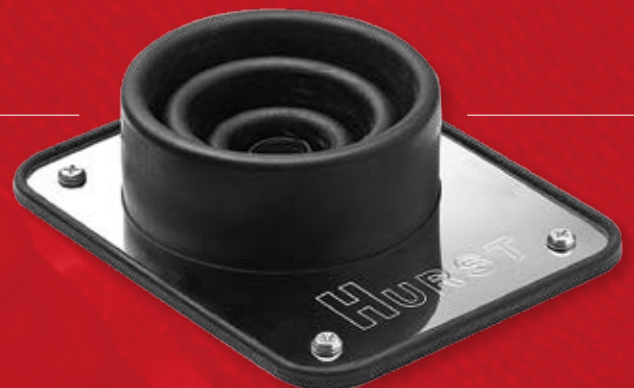

B-1 BOOT & PLATE • PART #1147336

Designed for use with round stick shifters.
Complete with chrome ID plate & mounting hardware.
Measures 4-3/8" x 5-3/8" - 3 pleats

UNIVERSAL PISTOL-GRIP™

With Optional 12V Auxiliary Switch



ABOUT HURST UNIVERSAL PISTOL-GRIP HANDLES

The Hurst Pistol-Grip shifter handle is designed to provide a firm, comfortable, and natural grip when shifting. With such a good grip on the control of your transmission, the chances of missing a shift are greatly reduced. Military-specified, anodized surface treatment ensures a good-looking, durable, and long-lasting finish.

HANDLE W/ 12V SWITCH	PART#
Aluminum	1536200
Black Anodized	1536210
HANDLE ONLY	
Aluminum	1531000
Black Anodized	1536010

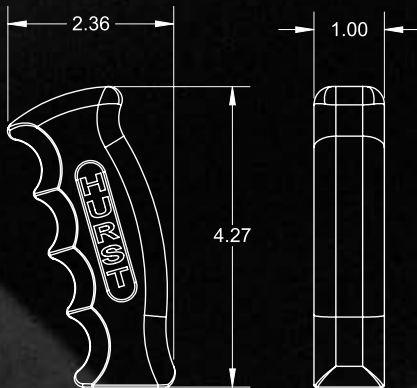

UNIVERSAL-FIT >> Multiple Thread Adaptors Included Complete with Adapters and Jam Nut:
3/8-16, 1/2-20, M10-1.25, M10-1.50, M12-1.25, M12-1.75, M16-1.50

MILITARY-SPECIFIED >> Military-Specified, Anodizing Surface Treatment

6061-T6 BILLET ALUMINUM >> CNC-Machined from Solid Billet 6061-T6 Aluminum

AUXILIARY SYSTEM CONTROL >> Switched Models Feature a Heavy-Duty 12V, 10A, Normally Open, Momentary Switch, Allowing for Control of Systems such as Roll Control, Nitrous, or a Transmission Brake.

UNIVERSAL T-HANDLE®

With Optional 12V Auxiliary Switch



ABOUT HURST T-HANDLES

The Hurst T-Handle is not only pleasing to the eye, but incredibly ergonomic. The length and contours of the handle allow for a firm grasp and confident shifts from gear to gear. For strength and durability, the Hurst T-handle is made of solid, die-cast aluminum.

- » Die-Cast Aluminum Alloy
- » Perfect, Ergonomic Grip
- » Chrome, Brushed, or Polished Finish
- » Complete with Adapters and Jam Nut

THREAD SIZE

UNIVERSAL T-HANDLES	FINISH	PART #
SAE 1/4-28, 5/16-18, 3/8-16, and 1/2-20	Chrome	1530032
SAE (including 3/8-24) and Metric*	Chrome	1530060
SAE and Metric*	Polished	1530040
SAE and Metric*	Brushed	1530020
T-HANDLE W/ BUTTON		
SAE and Metric*	Polished	1530011
SAE and Metric*	Brushed	1530010

* Includes SAE 3/8"-16, 7/16"-20, 1/2"-20, and Metric M10-1.25, M10-1.50, M12-1.25, M12-1.75, M16-1.50

4-SPEED HURST LOGO T-HANDLE PART# 1535000



Fits Hurst Comp Plus chrome-plated shifter sticks with 3/8-16 threads

THREAD SIZE CHART

HURST SHIFTER	THREAD	HURST SHIFTER	THREAD	OEM SHIFTER	THREAD
Aluminum sticks	7/16"-20	Indy Pick Up Truck	3/8"-24	Camaro 5/6-speed internal rail	16mm x 1.50
Auto/Stick 1	3/8"-16	Indy Qualifier	3/8"-16	With OEM stick	
Auto/Stick 3	3/8"-16	Indy SSA	3/8"-24	Firebird 5/6-speed internal rail	16mm x 1.50
Billet Plus w/chrome stick	3/8"-16	Pro-Matic, before 1987	1/2"-13	With OEM stick	
Billet Plus w/black stick	OEM	Pro-Matic 2, since 1987	3/8"-16	Mustang 5/6-speed internal rail	12mm x 1.75
Chrome replacement sticks	3/8"-16	Quarter/Stick and Q/S 2	7/16"-20	With OEM stick ('79-'04)	
Comp/Plus (early)	3/8"-24	Quick/Stick	OEM	Mustang '05-'10	12mm x 1.25
Comp/Plus (late), and OEM	3/8"-16	Super Shifter 3	3/8"-16	Corvette 6-speed 89-04	9/16"-18
Dual/Gate 2	3/8"-16	Vertical Gate, before 1987	1/2"-13	Viper	1/2"-20
Indy 3-speed	3/8"-24	V-Gate 2, since 1987	3/8"-16	B&M Shifters/Most automatic shifters	1/2"-20
Indy Matic 1	3/8"-24	V-Matic, before 1987	1/2"-13	Most automatic shifters	

PRO-MATIC 2™

Automatic Ratchet Shifter

ABOUT THE HURST PRO-MATIC 2

The Hurst Pro-Matic 2 ratchet-action shifter with its chrome-plated stick and black knob is quality engineered for years of precise, trouble-free operation. Once the shifter is installed, the brilliant top cover and textured console, which can be trimmed to fit any floor contour, integrates the shifter with the interior. While easy on the eyes, this shifter is not all about looks. On the street, you will enjoy the ride as you freely tap the stick from gear to gear. If you decide to transfer your beauty of a machine to the track, give it all you've got because this shifter is built to handle the most powerful shifts and the special positive reverse "Loc/Out" meets NHRA and IHRA technical requirements. This shifter comes complete with all the hardware required to make installation a breeze including a 5' long heavy-duty shifter cable and instructions. It also includes a neutral safety and back-up light switch assembly.

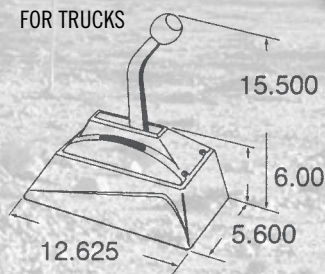
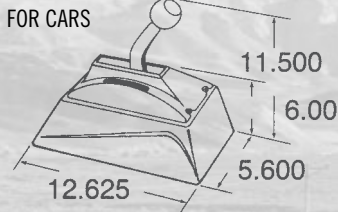

ADDITIONAL FEATURES

- » Progressively-Illuminated Gear Position Indicator
- » Cable-Operated to Provide Your Choice of Mounting Locations
- » Full-Forward and Reverse Ratchet Action can be Used with Either Standard or Reverse Pattern Valve Bodies

MAKE	TRANSMISSION	CAR	TRUCK
GM	TH 250, 350, 375, 400	3838500	3838510
Ford	C-4, C-6 and AOD	3838500*	3838510*
Mopar	Torqueflite A727-A904	3838500	3838510
AMC	Torque Command A727-A904	3838500	3838510

* Will fit AOD with B&M #40496 lever and bracket kit.

V-MATIC 3™

Automatic Ratchet Shifter

ABOUT THE HURST V-MATIC 3

The Hurst V-Matic 3 is the pinnacle of performance shifters. At the end of 2012, the V-Matic 2 was replaced by the V-Matic 3. The engineers at Hurst shifters decided to go with a new mechanical design that would eliminate hang-ups between shifts and achieve a quicker, smoother, and more positive shift than its predecessor. If you are looking for a high-performance ratchet shifter that is robust and stout, the Hurst V-Matic is the perfect choice. This shifter comes complete with all hardware required to make installation a trouble-free task.

TRANSMISSION	PART #
GM TH 250,350, 400, 700R4	3838530
Ford C-4, C-6 and AOD	3838530*
Mopar Torqueflite A727 and A904	3838530
AMC Torqueflite A727 and A904	3838530

* Will fit AOD with B&M #40496 lever/bracket kit.

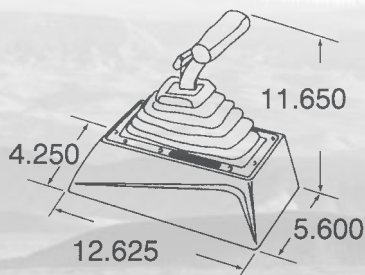

ADDITIONAL FEATURES

- » Attractive, Black-Textured Console with Chrome-Plated Top Cover can be Trimmed to Fit any Floor Contour
- » Back-Lit Gear Position Indicator
- » Complete with Hardware, 5' Long Heavy-Duty Shifter Cable, and Instructions
- » Chrome-Plated Stick and Brushed-Aluminum T-Handle
- » Can be Used with Standard or Reverse Pattern Valve Body
- » Cable-Operated for Quick Installation and Accurate Shifting
- » Incorporates a Neutral Safety and Back-Up Light Switch Assembly
- » Special Positive Reverse "Loc/Out" for NHRA and IHRA Technical Requirements

QUARTER STICK®

Automatic Gated Shifters

ABOUT HURST QUARTER STICKS

The Hurst Quarter Stick is considered the purest form of race shifter. This shifter was designed for the people that wanted a no-compromise, lightweight, and compact shifter for 2 and 3-speed automatic transmissions in forward and reverse valve body shift patterns. The one-hand-operated, spring loaded, reverse "Loc/Out" mechanism meets NHRA and IHRA technical requirements and enables drivers to clear the reverse lockout while remaining strapped into their shoulder harness belts. These features, along with the fact that it is extremely compact and lightweight for tight-fit cockpit installation, have made the Quarter Stick immensely popular with race car drivers.

If you have a rear-engine dragster, the Quarter Stick 2 would be your best shifter choice. It has the same mechanisms as the Quarter Stick but with a rear cable exit. This allows for easier installation, positive shifts, and a lower probability of cable binding.

ADDITIONAL FEATURES

- >> Forged-Aluminum Stick for Added Strength (7/16"-20 top thread)
- >> Controlled Gate Stop Provides Fast Gear Changes while Eliminating Overshifts
- >> Comes with Hardware, 5' Long Heavy-Duty Shifter Cable, Factory-Installed Neutral Safety Switch, and Easy-to-Follow Installation Guide (Back-Up Light Switch is Available Separately)



ORIGINAL QUARTER STICK	VALVE BODY	PART#
Powerglide (Alum. case only)	Forward & Reverse	3160001
TH 250, 350, 375 & 400	Forward	3160006
TH 250, 350, 375 & 400	Reverse	3160001
Chrysler/AMC A727, A904	Forward	3160009
Ford C-4, C-6	Forward	3160009
Chrysler/AMC A727, A904	Reverse	3160014
Ford C-4, C-6	Reverse	3160014

QUARTER STICK 2 (REAR CABLE EXIT)	VALVE BODY	PART#
Powerglide	Forward & Reverse	3160020
TH 250, 350, 375 & 400	Reverse	3160020

QUARTER STICK SHIFT GATE PATTERNS

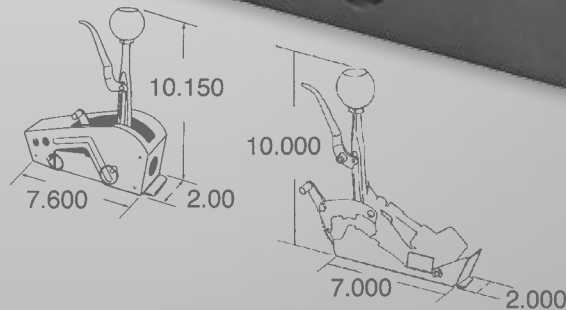
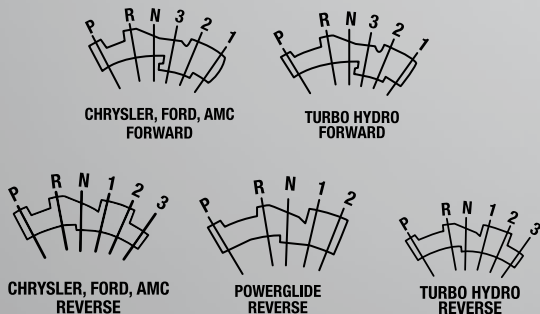

QUARTER STICK®

Pistol-Grip Automatic Gated Shifters

ABOUT HURST PISTOL-GRIP QUARTER STICKS

The Hurst Pistol-Grip Quarter Stick Shifter is designed for a firm, comfortable, natural grip, providing a positive feel when shifting. Wouldn't it be great if there was a shifter that had the same great features of the Quarter Stick but with an ergonomic handle? Then integrate a precision snap-action momentary (normally-open) switch ideal for operating a Hurst Roll Control, nitrous system, or transmission brake. That's how the Pistol-Grip Quarter Stick was born! The handle is CNC-machined from billet aluminum for exceptional strength and is contoured like a pistol-grip for ergonomics. The Pistol-Grip Quarter Stick 2 has a rear-exit cable design for rear-engine applications.

ORIGINAL QUARTER STICK	VALVE BODY	FINISH	PART#
Powerglide (Alum. case only)	Fwd & Rev	Aluminum	3162001
Powerglide (Alum. case only)	Fwd & Rev	Black Anodized	3162002
TH 250, 350, 375 & 400	Forward	Aluminum	3162006
TH 250, 350, 375 & 400	Forward	Black Anodized	3162007
TH 250, 350, 375 & 400	Reverse	Aluminum	3162001
TH 250, 350, 375 & 400	Reverse	Black Anodized	3162002
Chrysler/AMC A727, A904	Forward	Aluminum	3162009
Ford C-4, C-6	Forward	Aluminum	3162009
Chrysler/AMC A727, A904	Forward	Black Anodized	3162010
Ford C-4, C-6	Forward	Black Anodized	3162010
Chrysler/AMC A727, A904	Reverse	Aluminum	3162014
Ford C-4, C-6	Reverse	Aluminum	3162014
Chrysler/AMC A727, A904	Reverse	Black Anodized	3162015
Ford C-4, C-6	Reverse	Black Anodized	3162015
QUARTER STICK 2 (REAR CABLE EXIT)			
Powerglide	Fwd & Rev	Aluminum	3162020
TH 250, 350, 375 & 400	Reverse	Aluminum	3162020

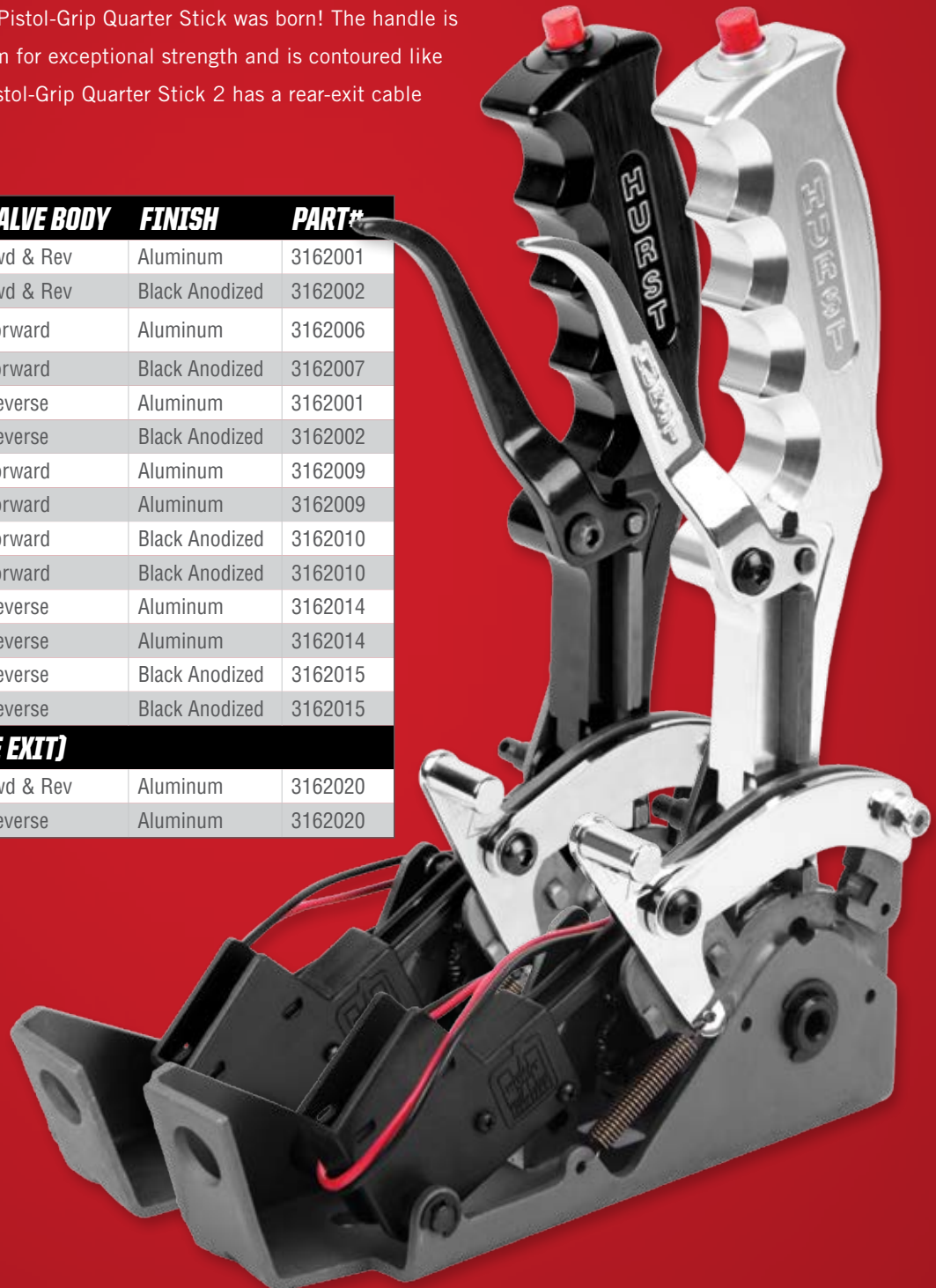
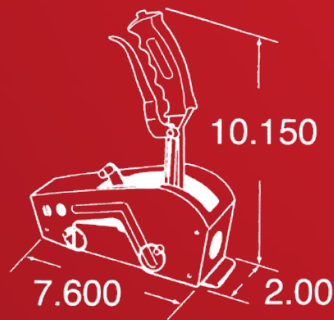

QUARTER STICK®

Accessories

ALUMINUM COVER KIT

Brushed - Part #1300041

Black Anodized - Part #1300051



Adds a professional, finished look to your Quarter Stick or Pistol Grip installation. Attaches to shifter with quick-release pins (included) and may be used in conjunction with the aluminum mounting plate kit. Does not fit Quarter Stick 2 or Pistol Grip 2.

PLASTIC COVER KIT

Quarter Stick & Pistol Grip - Part #1300055

Quarter Stick 2 & Pistol Grip 2 - Part #1300056



Adds a distinctive, finished look to your Quarter Stick installation. Mounting plate and button head screws are included with the plastic cover kit.

ALUMINUM MOUNTING PLATE KIT

Mounting Plate - Part #1950225

Replacement Pin - Part #1890082



Clear, anodized aluminum mounting plate offers mounting flexibility and allows for quick shifter removal via quick-release pins (included).

BACK-UP LIGHT SWITCH KIT

Part #2488601



Kit includes back-up light switch and hardware. Easy installation for all Quarter Stick and Pistol Grip shifters having front cable exit.

QUARTER STICK®

Accessories



SOLENOID SHIFTING KIT

Part #2260020

The Hurst Electric Solenoid Shifting Kit was designed to automatically complete the 1st to 2nd gear change, increasing shifting reliability and improving E.T. consistency.

- » Engineered for forward-pattern Hurst Quarter Sticks.
- » Shifting is controlled when used with an rpm-activated switch or manually-activated push button (normally open) switch.

The solenoid features a spring-activated plunger and is designed to quickly and firmly push the shifter stick into gear, not hit or slam it, which can cause damage to the stick itself.

- » Kit includes a heavy-duty 12-volt solenoid rated at maximum 3-amp draw to hold the plunger in position, aluminum mounting bracket, hardware, fuse, and electrical connectors.

COMPETITION SHIFTER KNOB W/ BUILT-IN 12V SWITCH

Part #1630050



Now with snap-action for instant activation, this black, molded ABS knob is ideal for use with Hurst Roll Control, or other nitrous oxide systems, or other 12-volt accessories. 7/16" x 20 thread size, application for Quarter Stick.

NEUTRAL/PARK START SAFETY SWITCH

Part #2488600



Kit includes switch and mounting hardware. Easy installation for all existing Quarter Sticks. (Newer Quarter Sticks and Pistol Grip shifters feature the switch installed from the factory.) Fits front and rear-exit cable shifters.

NEW!

PISTOL-GRIP™

Automatic Shifter Sticks

ABOUT HURST PISTOL-GRIP AUTOMATIC SHIFTER STICKS

Hurst introduces their all new Pistol-Grip handle for automatic Camaros, Challengers, Chargers and Mustangs. This is a great way to add a contemporary performance look to your modern day muscle car. Billet Aluminum construction is precision CNC machined for a modern look and feel. The body features a polished finish, while the replaceable grip plates have a black anodized finish and display the iconic Hurst name. The grip features a comfortable shape that just feels “right” in your hand, along with a finger operated trigger mechanism for the lockout function. Easily installed with simple hand tools, and carries a Lifetime Limited Warranty.

FEATURES & BENEFITS

- » CNC-Machined 6061-T6 Billet Aluminum
- » Trigger Operated Lockout Function
- » Black Anodized Replaceable Grip Plates
- » Easy Bolt-On Installation



5380435
15-17 MUSTANG



5380436
16-17 CAMARO



5380437
15-16 CHALLENGER/CHARGER

COMP STICK KIT™

Dodge Challenger



FITS 3RD GENERATION CHALLENGER

Add a unique touch to this instant classic with a brand synonymous with classic American muscle, Hurst. The Comp Stick Kit comes with a polished stainless steel Hurst engraved stick, classic Hurst ball knob, and the "Challenger" script engraved into the plate. If you have an automatic Challenger, this is a must accessory to the car! Choose between a black anodized or polished finish.



CNC MACHINED >> Aluminum Base Plate with "Challenger" Script

STAINLESS STEEL >> Hurst Engraved Handle

CHOICE OF FINISH >> Polished Aluminum with White Knob or Black Anodized with Black Knob

FINISH	MAKE	MODEL	YEAR	PART #
Black Anodized Aluminum	Dodge	Challenger w/ AutoStick Feature	08-12	5380402
Polished Aluminum	Dodge	Challenger w/ AutoStick Feature	08-12	5380403



ACCESSORIES

HURST PIT PACKS

Available in either steel or nylon. Steel bushings are designed to take the punishment of racing applications and provide for longer service. Nylon bushings are designed for street applications and eliminate most of the stick vibrations. These pit packs can be used on the Master Shift 3-Speed, Competition Plus 4-Speed, or the V-Gate 2. Kit includes either 6 or 7 steel or nylon bushings and spring clips. (Quantity and material are kit dependent.)

STANDARD PIT PACKS

APPLICATION	BUSHING	PART #
3, 4, and 5-speed manuals	Nylon bushings	3320001
3, 4, and 5-speed manuals	Steel bushings	3327302
V-Gate 2 only	Steel bushings	3321657
Billet Plus 3916030 (10-15 Camaro)	Stainless Steel/ T-500 Polymer bushings	3326030
Billet Plus 3915201 (05-10 Mustang)	Stainless Steel/ T-500 Polymer bushings	3326030

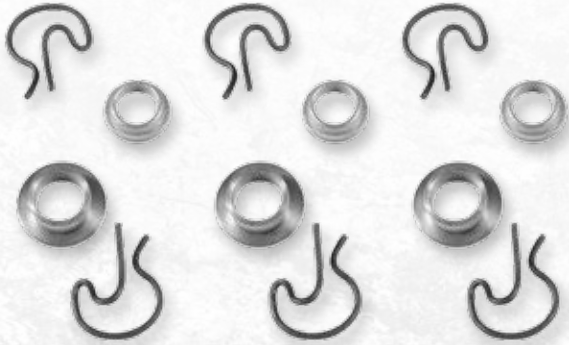

HURST SHIFTER CABLES

Replacement shifter cables are available for all Hurst automatic shifters. Additionally, several lengths of cables are available for the Quarter Stick and Pistol Grip shifters. These premium quality cables feature a solid 303 stainless steel inner wire core encased within a nylon liner wrapped with helical lay wires and swaged ends for superior strength. The core is lubricated with Teflon prior to assembly and then sealed in a heavy plastic outer casing for durability and smooth operation. Make sure the cable is not kinked, bent in too tight of a radius, touching the exhaust manifold, or dragging. If this occurs, make adjustments to eliminate the problem.

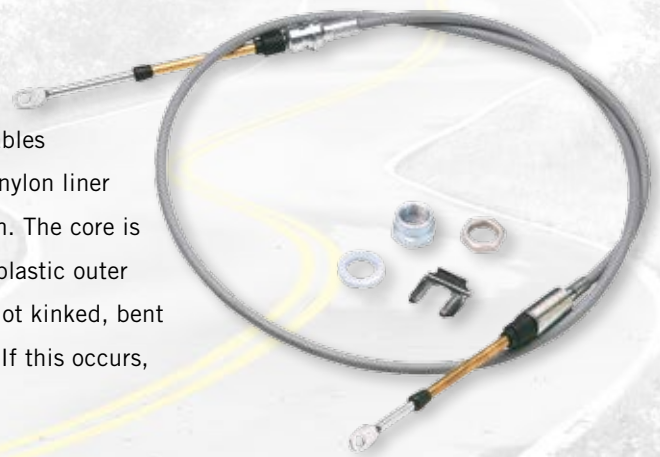

STANDARD REPLACEMENT CABLES

CABLE LENGTH	PART #	VISUAL	NOTES
3 ft. Adjustable Single Eyelet	5000023		Auto Stick 3, Pistol Grip, Q-Stick/Q-Stick 2, Lightning Rods Pick-up Truck Auto stick, Dual Gate 2, Van Auto Stick
5 ft. Adjustable Single Eyelet	5000025*		
8 ft. Adjustable Single Eyelet	5000028		
5 ft. Adjustable Double Eyelet	5000029**		Q-Stick (Late model Camaro, Monte Carlo)
5 ft. Adjustable Single Eyelet	5008555**		Pro Matic 2, All V-Matic Shifters

* Standard cable for most Quarter Stick shifters. ** Standard cable for the Pro Matic 2 and V-Matic 2.

BACK-UP LIGHT SWITCH • PART #2480003

This switch is designed to be used in conjunction with OEM back-up lights, the Competition/Plus 4-Speed, Super/Shifter 3, and Master Shift 3-Speed shifters.



NEED SERVICE PARTS?

- » **SHIFTER SPRINGS**
- » **TRANS ARMS**
- » **HARDWARE**
- » **CABLES**
- » **CONSOLES**
- » **SHIFTER BOOTS**
- » **CABLE BRACKETS**
- » **MOUNTING PLATES**
- » **AND MUCH MORE!**



HURST WARRANTY INFORMATION

Lifetime Limited Warranty applies to all Hurst shifters, exhaust kits, wheels and suspension kits (springs, sway bars, etc.).

One Year Limited Warranty applies to all Hurst shifter related accessories (knobs, handles, etc.), and other non-shifter related accessories (floor mats, decal kits, etc.).

90 Day Limited Warranty applies to Hurst Roll Control kits and all electrical components (switches, lights, solenoids).

Hurst Performance ("Hurst") extends the following limited warranty to products purchased after August 1, 2015 to the original purchaser of its shifters, exhaust kits, wheels, suspension kits, components and accessories (hereafter "products").

Hurst warrants the products mentioned above against defects in materials and workmanship for the period set forth below, when they are owned by the original purchaser and remain installed on the vehicle on which they were originally installed. This warranty is void if the product was not installed properly on the vehicle, was installed on a vehicle for which it was not designed, or was removed from the vehicle on which it was originally installed and reinstalled on another vehicle. This warranty shall not apply to normal wear (bushings, springs, etc.), cosmetic issues such as coatings and material discoloration, or any product that was installed on a racing vehicle (excluding shifters), installed contrary to Hurst instructions, or altered, misused, repaired, damaged from an accident, collision, undercarriage road impact or debris, or willful or negligent act.

The warranty set forth herein for all Hurst shifters, exhaust kits, wheels and suspension kits (springs, sway bars, etc.) extends for a period of the life of the original vehicle the product was installed on. The warranty set forth herein for all Hurst shifter related accessories (knobs, handles, etc.), and other non-shifter related accessories (floor mats, decal kits, etc.), extends for a period of one year from the date of original purchase and the original vehicle it was installed on. The warranty set forth herein for Hurst Roll Control kits and all electrical components (switches, lights, solenoids) extends for a period of 90 days from the date of original purchase and the original vehicle it was installed on.

To make any claim under the terms of this limited warranty, the original purchaser **MUST** either return the product to the original retailer or directly to Hurst. If the original purchaser elects to return the product to Hurst directly, he or she must first contact Hurst and obtain a Returned Material Authorization (RMA) number. The Proof of Purchase must clearly show the place of purchase, purchase price, product purchased, and date of purchase. If upon inspection by Hurst the product is found to be defective in material or workmanship, Hurst shall at its option, either exchange the product for new product with the same part number or refund the original purchase price.

This warranty is not contingent upon the purchaser's completion of the Warranty Registration Form found on the Hurst website. If however the purchaser completes and submits that form at the time of purchase, Hurst will keep that form on file which may serve as an aid in determining warranty coverage in the event of the loss of the original purchase receipt.

Hurst's liability is expressly limited to the replacement of the product or refund of the purchase price as described herein. Hurst shall have no liability for the cost of installation or removal of the defective product, for the cost of labor or any additional parts required to complete the installation of the replacement product, towing or transportation costs, or return shipping costs. In no event shall Hurst be liable for any direct, indirect, special, incidental or consequential losses and/or damages, including but not limited to interruption of business or loss of business or loss of profit or damage to related components resulting from the use of or inability to use the product, or any breach of warranty or any defect in the product, even if Hurst shall have been advised of the possibility of such potential losses or damages. Some states do not allow the exclusion or limitation of incidental or consequential damages, so the above limitation or exclusion may not apply to you. This warranty gives you specific legal rights. You may also have other rights which may vary from state to state.

The warranties set forth herein are exclusive and unless otherwise required by applicable law no other warranties are made by Hurst or are authorized to be made with respect to the product.

3-SPEED TRANSMISSION I.D. CHART

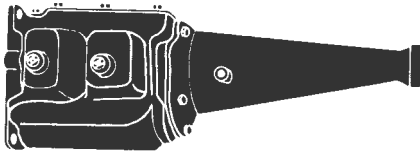

FORD (333)

9-bolt top cover; first-gear synchronized

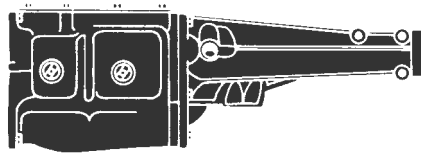

FORD (336)

9-bolt top cover; first-gear synchronized



FORD (337)

4 or 6 bolt top cover; first-gear not synchronized

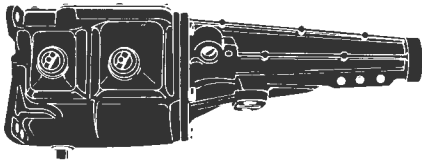

FORD (339)

9-bolt top cover; first-gear synchronized



CHEVROLET (341)

4-bolt side cover with round-gear selection shafts

Tapped holes on Corvette models only

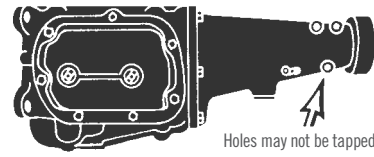

SAGINAW (343)

7-bolt side cover; first-gear synchronized

Holes may not be tapped

CAUTION: This transmission closely resembles 351 Muncie

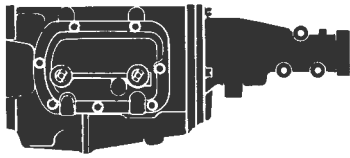

MUNCIE (351)

7-bolt side cover; first-gear synchronized

CAUTION: This transmission closely resembles 343 Saginaw

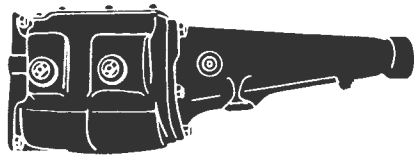

TREMEC (352)

9-bolt top cover; first-gear synchronized

4-SPEED TRANSMISSION I.D. CHART

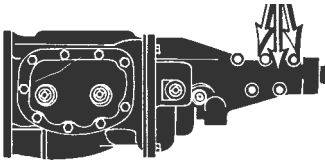

BORG-WARNER T-10, GM AS-3 (410)

9-bolt curved-bottom side cover

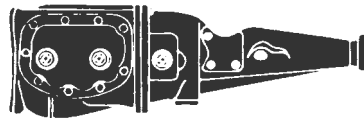

BORG-WARNER T-10, SUPER T-10, FORD/MERCURY (411)

9-bolt curved-bottom side cover

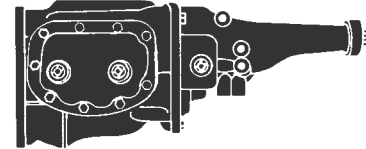

BORG-WARNER T-10, FORD/MERCURY (412)

9-bolt curved-bottom side cover

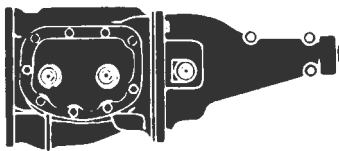

BORG-WARNER T-10 FORD/MERCURY (413)

9-bolt curved-bottom side cover

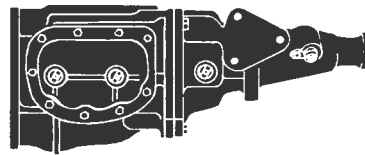

BORG-WARNER T-10, FORD/MERCURY (414)

9-bolt curved-bottom side cover

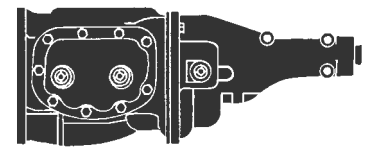

BORG-WARNER T-10 (415)

4-bolt side cover with round-gear selection shafts



NEW PROCESS, MOPAR A-BODY (421)

10-bolt side cover

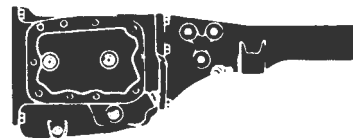

NEW PROCESS, MOPAR B-BODY (422)

10-bolt side cover

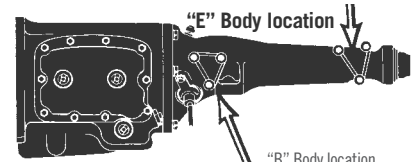

NEW PROCESS, MOPAR (423)

10-bolt side cover

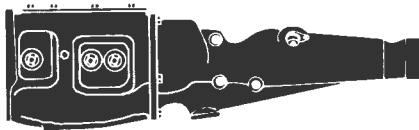

FORD T & C, FORD/MERCURY (431)

10-bolt top cover

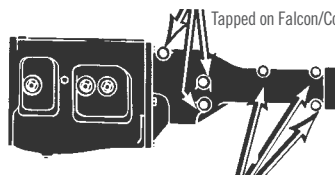

FORD 3+1 OVERDRIVE T & C, FORD/MERCURY (432)

10-bolt top cover

Tapped on Falcon/Comet

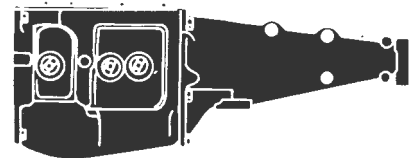

FORD T & C, FORD/MERCURY (433)

10-bolt top cover

4-SPEED TRANSMISSION I.D. CHART

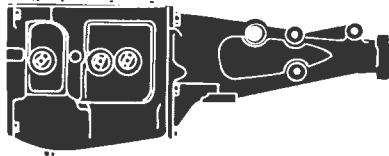

FORD T & C, FORD/MERCURY (434)
10-bolt top cover



FORD 3+1 OVERDRIVE FORD/MERCURY (435)

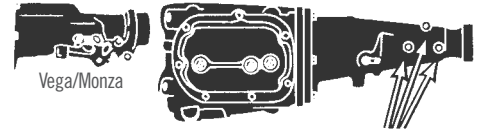

Vega/Monza
SAGINAW, G.M. (441)
7-bolt side cover
Holes may not be tapped

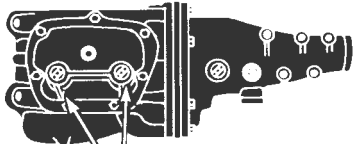

Transmission arms attach with stud and nut*
MUNCIE M-20/M-21 EARLY, G.M. (451)
7-bolt side cover used from 63-68

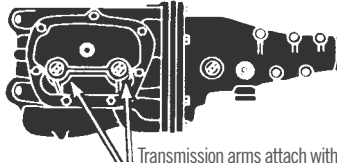

Transmission arms attach with bolt*
MUNCIE M-20/M-21, G.M. (452)
7-bolt side cover 1969 and later

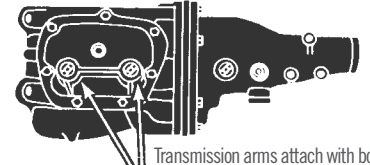

Transmission arms attach with bolt
MUNCIE M-22 (453)
G.M. 7-bolt side cover 1970, 454 Chevelle

*MUNCIE Shaft Identification:

The above Muncie 4-speed transmissions can be distinguished from the style of the transmission arm attachment. Pre-1969 Muncies use a stud and nut at the indicated attachment point, while 1969 and later Muncies use a bolt as illustrated on the right.



PRE 69' MUNCIE & ALL
BORG-WARNER SHAFTS
TRANS ID 451



69' & LATER MUNCIE
TRANS ID 452,453

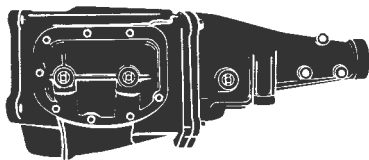

RICHMOND/BORG-WARNER SUPER T-10, (AS-9) 1974 AND LATER (454)
9-bolt curved-bottom side cover

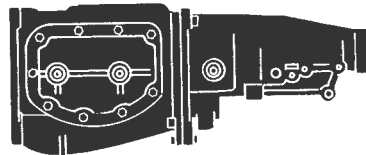

BORG-WARNER TORQUE TUBE TAILSHAFT, G.M. (455)
81-82 CAMARO/FIREBIRD
9-bolt side cover

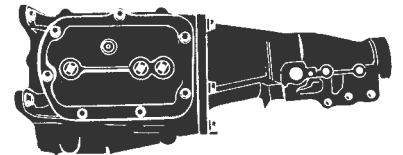

SAGINAW TORQUE TUBE TAILSHAFT, G.M. 81-82 CAMARO/FIREBIRD (456)
First-gear synchronized

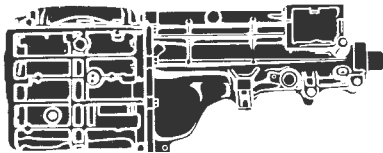

BORG-WARNER T-4 (464)
Internal Rail

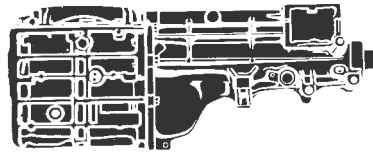

BORG-WARNER T-5, GENERAL MOTORS (464)
Internal Rail

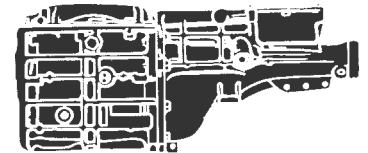

BORG-WARNER T-5, FORD (465)
Internal Rail

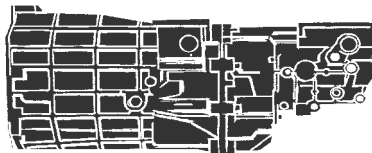

BORG-WARNER T-56, G.M. (468)

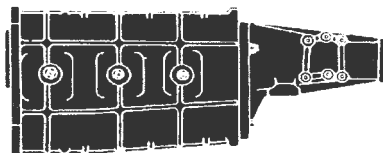

RICHMOND GEAR DOUG NASH/ G-FORCE 5-SPEED (467)

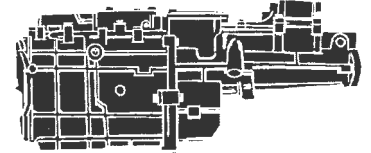

TREMEC 3550 (469)

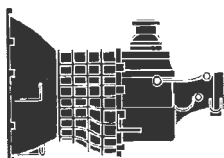

NEW VENTURE MG-5 (466)
G.M. & Dodge Truck

HURST GEAR

& Apparel



SIZE	PART #
Small	652201
Medium	652202
Large	652203
X-Large	652204
2X-Large	652205
3X-Large	652207

HURST NOSTALGIA II T-SHIRT, BLACK

Constructed from premium-quality, 100% pre-shrunk cotton and printed in vivid, fade-resistant colors, these quality-made tees have a classic Hurst Line-Loc logo on the front and an illustration of the mighty Hurst Hemi Under Glass on the back.



SIZE	PART #
Small	653100
Medium	653101
Large	653102
X-Large	653103
2X-Large	653104
3X-Large	653105

HURST LOGO T-SHIRT, BLACK

Show your Hurst pride with this premium-quality, 100% pre-shrunk cotton t-shirt. Celebrate Hurst's rich history and bright future with this modern-day re-imagining of the iconic logo mark.



HURST LOGO HAT • PART #652211

These Hurst hats are top-quality hats made from 100% cotton with a Velcro back strap for size adjustments. The two-color embroidery on the front of the cap lets everyone know that you're part of the Hurst team!



HURST LOGO BANNER • PART #651416

Show off your Hurst pride in a big way with this banner! Measuring 48"x34", this large banner is the perfect addition to any garage, shop or man cave. Made from heavy weight 8 mil poly vinyl, along with a sewn in perimeter and heavy duty grommets at all four corners.



HURST-EQUIPPED EMBLEM • PART #1361000

Based on original Hurst blueprints, this Hurst-Equipped emblem is an authentic reproduction of the one used on the late 1960s muscle cars equipped with a factory Hurst shifter. Made of durable ABS material with 3M adhesive tape backing for permanent mounting. Nominal size is 1-1/4" high by 5-1/4" long. Individually packaged.

2016 Mr. Norm's Hurst Edition GSS Patriot Challenger



